

Internet Engineering Task Force (IETF)  
Request for Comments: 6731  
Category: Standards Track  
ISSN: 2070-1721

T. Savolainen  
Nokia  
J. Kato  
NTT  
T. Lemon  
Nominum, Inc.  
December 2012

## Improved Recursive DNS Server Selection for Multi-Interfaced Nodes

### Abstract

A multi-interfaced node is connected to multiple networks, some of which might be utilizing private DNS namespaces. A node commonly receives recursive DNS server configuration information from all connected networks. Some of the recursive DNS servers might have information about namespaces other servers do not have. When a multi-interfaced node needs to utilize DNS, the node has to choose which of the recursive DNS servers to use. This document describes DHCPv4 and DHCPv6 options that can be used to configure nodes with information required to perform informed recursive DNS server selection decisions.

### Status of This Memo

This is an Internet Standards Track document.

This document is a product of the Internet Engineering Task Force (IETF). It represents the consensus of the IETF community. It has received public review and has been approved for publication by the Internet Engineering Steering Group (IESG). Further information on Internet Standards is available in Section 2 of RFC 5741.

Information about the current status of this document, any errata, and how to provide feedback on it may be obtained at <http://www.rfc-editor.org/info/rfc6731>.

### Copyright Notice

Copyright (c) 2012 IETF Trust and the persons identified as the document authors. All rights reserved.

This document is subject to BCP 78 and the IETF Trust's Legal Provisions Relating to IETF Documents (<http://trustee.ietf.org/license-info>) in effect on the date of publication of this document. Please review these documents carefully, as they describe your rights and restrictions with respect

to this document. Code Components extracted from this document must include Simplified BSD License text as described in Section 4.e of the Trust Legal Provisions and are provided without warranty as described in the Simplified BSD License.

## Table of Contents

1.	Introduction . . . . .	3
1.1.	Requirements Language . . . . .	4
2.	Private Namespaces and Problems for Multi-Interfaced Nodes . .	4
2.1.	Fully Qualified Domain Names with Limited Scopes . . . . .	4
2.2.	Network-Interface-Specific IP Addresses . . . . .	5
2.3.	A Problem Not Fully Solved by the Described Solution . . .	6
3.	Deployment Scenarios . . . . .	7
3.1.	CPE Deployment Scenario . . . . .	7
3.2.	Cellular Network Scenario . . . . .	7
3.3.	VPN Scenario . . . . .	8
3.4.	Dual-Stack Accesses . . . . .	8
4.	Improved RDNSS Selection . . . . .	8
4.1.	Procedure for Prioritizing RDNSSes and Handling Responses . . . . .	9
4.2.	RDNSS Selection DHCPv6 Option . . . . .	11
4.3.	RDNSS Selection DHCPv4 Option . . . . .	13
4.4.	Scalability Considerations . . . . .	15
4.5.	Limitations on Use . . . . .	15
4.6.	Coexistence of Various RDNSS Configuration Tools . . . . .	16
4.7.	Considerations on Follow-Up Queries . . . . .	17
4.8.	Closing Network Interfaces and Local Caches . . . . .	17
5.	Example of a Node Behavior . . . . .	17
6.	Considerations for Network Administrators . . . . .	19
7.	IANA Considerations . . . . .	20
8.	Security Considerations . . . . .	20
8.1.	Attack Vectors . . . . .	20
8.2.	Trust Levels of Network Interfaces . . . . .	21
8.3.	Importance of Following the Algorithm . . . . .	21
9.	References . . . . .	21
9.1.	Normative References . . . . .	21
9.2.	Informative References . . . . .	22
Appendix A.	Possible Alternative Practices for RDNSS Selection . .	23
A.1.	Sending Queries Out on Multiple Interfaces in Parallel . .	23
A.2.	Search List Option for DNS Forward Lookup Decisions . . .	23
A.3.	More-Specific Routes for Reverse Lookup Decisions . . . .	24
A.4.	Longest Matching Prefix for Reverse Lookup Decisions . . .	24
Appendix B.	DNSSEC and Multiple Answers Validating with Different Trust Anchors . . . . .	24
Appendix C.	Pseudocode for RDNSS Selection . . . . .	24
Appendix D.	Acknowledgements . . . . .	29

## 1. Introduction

A multi-interfaced node (MIF node) faces several problems a single-homed node does not encounter, as is described in [RFC6418]. This document studies in detail the problems private namespaces might cause for multi-interfaced nodes and provides a solution. The node might be implemented as a host or as a router.

We start from the premise that network operators sometimes include private, but still globally unique, namespaces in the answers they provide from Recursive DNS Servers (RDNSes) and that those private namespaces are at least as useful to nodes as the answers from the public DNS. When private namespaces are visible for a node, some RDNSes have information other RDNSes do not have. The node ought to be able to query the RDNSS that can resolve the query regardless of whether the answer comes from the public DNS or a private namespace.

An example of an application that benefits from multi-interfacing is a web browser that commonly accesses many different destinations, each of which is available on only one network. The browser therefore needs to be able to communicate over different network interfaces, depending on the destination it is trying to reach.

Selection of the correct interface and source address is often crucial in the networks using private namespaces. In such deployments, the destination's IP addresses might only be reachable on the network interface over which the destination's name was resolved. Henceforth, the solution described in this document is assumed to be commonly used in combination with tools for delivering additional routing and source and destination address selection policies (e.g., [RFC4191] and [RFC3442]).

This document is organized in the following manner. Background information about problem descriptions and example deployment scenarios are included in Sections 2 and 3. Section 4 contains all normative descriptions for DHCP options and node behavior. Informative Section 5 illustrates behavior of a node implementing functionality described in Section 4. Section 6 contains normative guidelines related to creation of private namespaces. The IANA considerations are in Section 7. Informational Section 8 summarizes identified security considerations.

Appendix A describes best current practices that are possible with tools preceding this document and that are possibilities on networks not supporting the solution described in this document. Appendix B discusses a scenario where multiple answers are possible to validate,

but with different trust anchors. Appendix C illustrates with pseudocode the functionality described in Section 4.

### 1.1. Requirements Language

The key words "MUST", "MUST NOT", "REQUIRED", "SHALL", "SHALL NOT", "SHOULD", "SHOULD NOT", "RECOMMENDED", "MAY", and "OPTIONAL" in this document are to be interpreted as described in RFC 2119 [RFC2119].

## 2. Private Namespaces and Problems for Multi-Interfaced Nodes

This section describes two private namespace scenarios related to node multi-interfacing for which the procedure described in Section 4 provides a solution. Additionally, Section 2.3 describes a problem for which this document provides only a partial solution.

### 2.1. Fully Qualified Domain Names with Limited Scopes

A multi-interfaced node can be connected to one or more networks that are using private namespaces. As an example, the node can simultaneously open a Wireless LAN (WLAN) connection to the public Internet, a cellular connection to an operator network, and a Virtual Private Network (VPN) connection to an enterprise network. When an application initiates a connection establishment to a Fully Qualified Domain Name (FQDN), the node needs to be able to choose the right RDNSS for making a successful DNS query. This is illustrated in Figure 1. An FQDN for a public name can be resolved with any RDNSS, but for an FQDN of the private name of an enterprise's or operator's service, the node needs to be able to correctly select the right RDNSS for the DNS resolution, i.e., do also network interface selection already before destination's IP address is known.

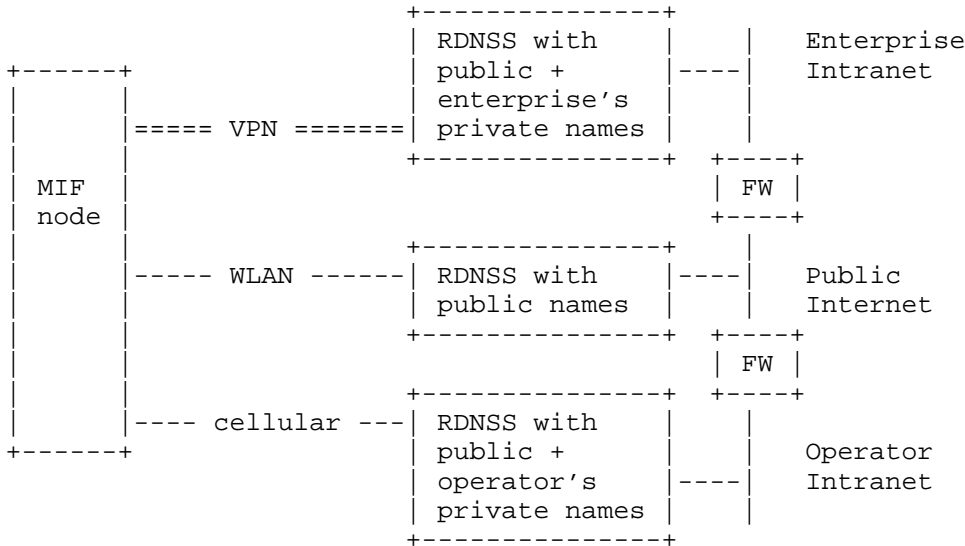

Figure 1: Private DNS Namespaces Illustrated

2.2. Network-Interface-Specific IP Addresses

In the second problem, an FQDN is valid and resolvable via different network interfaces, but to different and not necessarily globally reachable IP addresses, as is illustrated in Figure 2. The node's routing, source, and destination address selection mechanism has to ensure the destination's IP address is only used in combination with source IP addresses of the network interface on which the name was resolved.

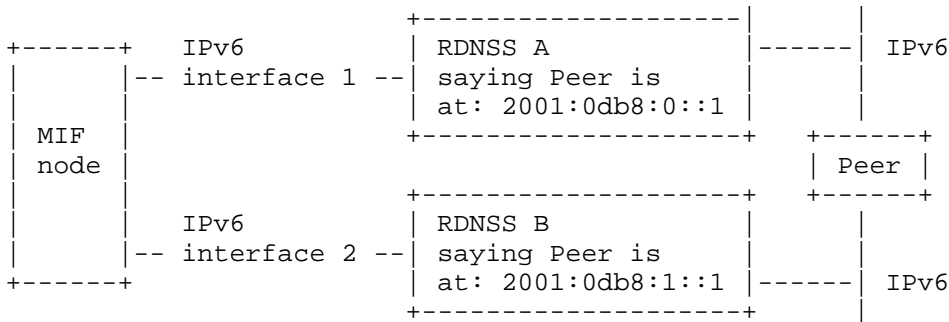

Figure 2: Private DNS Namespaces and Different IP Addresses for an FQDN on Interfaces 1 and 2

A similar situation can happen with IPv6 protocol translation and AAAA record synthesis [RFC6147]. A synthetic AAAA record is guaranteed to be valid only on the network on which it was synthesized. Figure 3 illustrates a scenario where the peer's IPv4 address is synthesized into different IPv6 addresses by RDNSSes A and B.

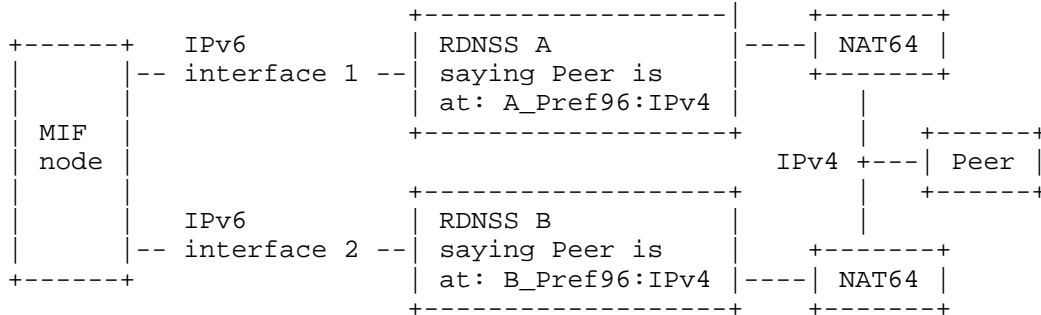

Figure 3: AAAA Synthesis Results in Network-Interface-Specific IPv6 Addresses

It is worth noting that network-specific IP addresses can also cause problems for a single-homed node, if the node retains DNS cache during movement from one network to another. After the network change, a node can have entries in its DNS cache that are no longer correct or appropriate for its new network position.

### 2.3. A Problem Not Fully Solved by the Described Solution

A more complex scenario is an FQDN, which in addition to possibly resolving into network-interface-specific IP addresses, identifies on different network interfaces completely different peer entities with potentially different sets of service offerings. In an even more complex scenario, an FQDN identifies a unique peer entity, but one that provides different services on its different network interfaces. The solution described in this document is not able to tackle these higher-layer issues. In fact, these problems might be solvable only by manual user intervention.

However, when DNS Security (DNSSEC) is used, the DNSSEC validation procedure can provide assistance for selecting correct responses for some, but not all, use cases. A node might prefer to use the DNS answer that validates with the preferred trust anchor.

### 3. Deployment Scenarios

This document has been written with three particular deployment scenarios in mind. The first is a Customer Premises Equipment (CPE) with two or more uplink Virtual Local Area Network (VLAN) connections. The second scenario involves a cellular device with two uplink Internet connections: WLAN and cellular. The third scenario is for VPNs, where use of a local RDNSS might be preferred for latency reasons, but the enterprise's RDNSS has to be used to resolve private names used by the enterprise.

In this section, we are referring to the RDNSS preference values defined in Section 4. The purpose of that is to illustrate when administrators might choose to utilize the different preference values.

#### 3.1. CPE Deployment Scenario

A home gateway can have two uplink connections leading to different networks, as described in [WITHOUT-IPV6NAT]. In the two-uplink scenario, only one uplink connection leads to the Internet, while the other uplink connection leads to a private network utilizing private namespaces.

It is desirable that the CPE does not have to send DNS queries over both uplink connections, but instead, CPE need only send default queries to the RDNSS of the interface leading to the Internet and queries related to the private namespace to the RDNSS of the private network. This can be configured by setting the RDNSS of the private network to know about listed domains and networks, but not to be a default RDNSS.

In this scenario, the legacy hosts can be supported by deploying DNS proxy on the CPE and configuring hosts in the LAN to talk to the DNS proxy. However, updated hosts would be able to talk directly to the correct RDNSS of each uplink ISP's RDNSS. It is a deployment decision whether the updated hosts would be pointed to a DNS proxy or to actual RDNSSes.

Depending on actual deployments, all VLAN connections might be considered trusted.

#### 3.2. Cellular Network Scenario

A cellular device can have both WLAN and cellular network interfaces up. In such a case, it is often desirable to use WLAN by default, except for the connections that the cellular network operator wants to go over the cellular interface. The use of WLAN for DNS queries

likely improves the power consumption of cellular devices and often provides lower latency. The cellular network might utilize private names; hence, the cellular device needs to ask for those through the cellular interface. This can be configured by setting the RDNSS of the cellular network to be of low preference and listing the domains and networks related to the cellular network's private namespaces as being available via the cellular network's RDNSS. This will cause a node to send DNS queries by default to the RDNSS of the WLAN interface (that is, by default, considered to be of medium preference) and queries related to private namespaces to the RDNSS of the cellular interface.

In this scenario, the cellular interface can be considered trusted and WLAN oftentimes untrusted.

### 3.3. VPN Scenario

Depending on a deployment, there might be interest in using VPN only for the traffic destined to a enterprise network. The enterprise might be using private namespaces; hence, related DNS queries need to be sent over VPN to the enterprise's RDNSS, while by default, the RDNSS of a local access network might be used for all other traffic. This can be configured by setting the RDNSS of the VPN interface to be of low preference and listing the domains and networks related to an enterprise network's private namespaces being available via the RDNSS of the VPN interface. This will cause a node to send DNS queries by default directly to the RDNSS of the WLAN interface (that is, by default, considered to be of medium preference) and queries related to private namespaces to the RDNSS of the VPN interface.

In this scenario, the VPN interface can be considered trusted and the local access network untrusted.

### 3.4. Dual-Stack Accesses

In all three scenarios, one or more of the connected networks can support both IPv4 and IPv6. In such a case, both or either of DHCPv4 and DHCPv6 can be used to learn RDNSS selection information.

## 4. Improved RDNSS Selection

This section describes DHCP options and a procedure that a (stub/proxy) resolver can utilize for improved RDNSS selection in the face of private namespaces and multiple simultaneously active network interfaces. The procedure is subject to limitations of use as described in Section 4.5. The pseudocode in Appendix C illustrates how the improved RDNSS selection works.



#### 4.1. Procedure for Prioritizing RDNSSes and Handling Responses

A resolver SHALL build a preference list of RDNSSes it will contact depending on the query. To build the list in an optimal way, a node SHALL request for RDNSS selection information with the DHCP options defined in Sections 4.2 and 4.3 before any DNS queries need to be made. With help of the received RDNSS selection information, the node can determine if any of the available RDNSSes have special knowledge about specific domains needed for forward DNS lookups or network addresses (later referred as "network") needed for reverse DNS lookups.

A resolver lacking more specific information can assume that all information is available from any RDNSS of any network interface. The RDNSSes learned by other RDNSS address configuration methods can be considered as default RDNSSes, but preference-wise, they MUST be handled as medium preference RDNSSes (see also Section 4.6).

When a DNS query needs to be made, the resolver MUST give highest preference to the RDNSSes explicitly known to serve a matching domain or network. The resolver MUST take into account differences in trust levels (see Section 8.2) of pieces of received RDNSS selection information. The resolver MUST prefer RDNSSes of trusted interfaces. The RDNSSes of untrusted interfaces can be of highest preference only if the trusted interfaces specifically configures low preference RDNSSes. The non-exhaustive list of cases in Figure 4 illustrates how the different trust levels of received RDNSS selection information influence the RDNSS selection logic. In Figure 4, "Medium", "High", and "Low" indicate the explicitly configured RDNSS's preference over other RDNSSes. The "Medium" preference is also used with RDNSSes for which no explicit preference configuration information is available. The "Specific domains" in Figure 4 indicate the explicitly configured "Domains and networks" private namespace information that a particular RDNSS has.

A resolver MUST prioritize between equally trusted RDNSSes with the help of the DHCP option preference field. The resolver MUST NOT prioritize less trusted RDNSSes higher than trusted, even in the case when a less trusted RDNSS would apparently have additional information. In the case of all other things being equal, the resolver can make the prioritization decision based on its internal preferences.

Information from more trusted interface A	Information from less trusted interface B	Resulting RDNSS preference selection
1. Medium preference default	Medium preference default	Default: A, then B
2. Medium preference default	High preference default Specific domains	Default: A, then B Specific: A, then B
3. Low preference default	Medium preference default	Default: B, then A
4. Low preference default Specific domains	Medium preference default	Default: B, then A Specific: A, then B

Figure 4: RDNSS Selection in the Case of Different Trust Levels

Because DNSSEC provides cryptographic assurance of the integrity of DNS data, it is necessary to prefer data that can be validated under DNSSEC over data that cannot. There are two ways that a node can determine that data is valid under DNSSEC. The first is to perform DNSSEC validation itself. The second is to have a secure connection to an authenticated RDNSS and to rely on that RDNSS to perform DNSSEC validation (signaling that it has done so using the AD bit). DNSSEC is necessary to detect forged responses, and without it any DNS response could be forged or altered. Unless the DNS responses have been validated with DNSSEC, a node cannot make a decision to prefer data from any interface with any great assurance.

A node SHALL send requests to RDNSSes in the order defined by the preference list until an acceptable reply is received, all replies are received, or a timeout occurs. In the case of a requested name matching to a specific domain or network rule accepted from any interface, a DNSSEC-aware resolver MUST NOT proceed with a reply that cannot be validated using DNSSEC until all RDNSSes on the preference list have been contacted or timed out. This protects against possible redirection attacks. In the case of the requested name not matching to any specific domain or network, the first received response from any RDNSS can be considered acceptable. A DNSSEC-aware node MAY always contact all RDNSSes in an attempt to receive a response that can be validated, but contacting all RDNSSes is not

mandated for the default case as that would consume excess resources in some deployments.

In the case of a validated NXDOMAIN response being received from an RDNSS that can provide answers for the queried name, a node MUST NOT accept non-validated replies from other RDNSSes (see Appendix B for considerations related to multiple trust anchors).

4.2. RDNSS Selection DHCPv6 Option

DHCPv6 option described below can be used to inform resolvers what RDNSS can be contacted when initiating forward or reverse DNS lookup procedures. This option is DNS record type agnostic and applies, for example, equally to both A and AAAA queries.

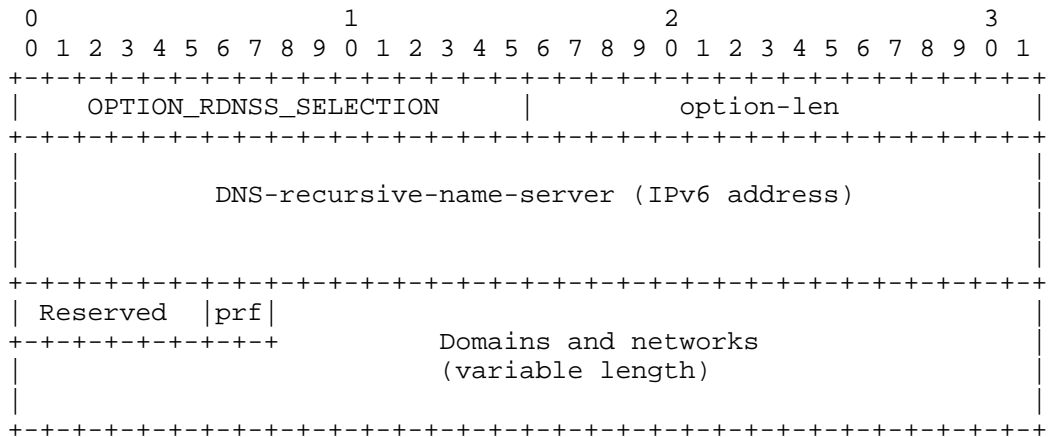

Figure 5: DHCPv6 Option for Explicit Domain Configuration

- option-code: OPTION\_RDNSS\_SELECTION (74)
- option-len: Length of the option in octets
- DNS-recursive-name-server: An IPv6 address of RDNSS
- Reserved: Field reserved for the future. MUST be set to zero and MUST be ignored on receipt.

prf: RDNSS preference:

01 High  
00 Medium  
11 Low  
10 Reserved

Reserved preference value (10) MUST NOT be sent. On receipt, the Reserved value MUST be treated as Medium preference (00).

Domains and networks: The list of domains for forward DNS lookup and networks for reverse DNS lookup about which the RDNSS has special knowledge. Field MUST be encoded as specified in Section 8 of [RFC3315]. A special domain of "." is used to indicate capability to resolve global names and act as a default RDNSS. Lack of a "." domain on the list indicates that the RDNSS only has information related to listed domains and networks. Networks for reverse mapping are encoded as defined for IP6.ARPA [RFC3596] or IN-ADDR.ARPA [RFC2317].

A node SHOULD include the Option Request Option (OPTION\_ORO [RFC3315]) in a DHCPv6 request with the OPTION\_RDNSS\_SELECTION option code to inform the DHCPv6 server about the support for the improved RDNSS selection logic. The DHCPv6 server receiving this information can then choose to provision RDNSS addresses only with OPTION\_RDNSS\_SELECTION.

OPTION\_RDNSS\_SELECTION contains one or more domains of which the related RDNSS has particular knowledge. The option can occur multiple times in a single DHCPv6 message, if multiple RDNSSes are to be configured. This can be the case, for example, if a network link has multiple RDNSSes for reliability purposes.

The list of networks MUST cover all the domains configured in this option. The length of the included networks SHOULD be as long as possible to avoid potential collision with information received on other option instances or with options received from DHCP servers of other network interfaces. Overlapping networks are interpreted so that the resolver can use any of the RDNSSes for queries matching the networks.

If OPTION\_RDNSS\_SELECTION contains an RDNSS address already learned from other DHCPv6 servers of the same network and contains new domains or networks, the node SHOULD append the information to the information received earlier. The node MUST NOT remove previously

obtained information. However, the node SHOULD NOT extend the lifetime of earlier information either. When a conflicting RDNSS address is learned from a less trusted interface, the node MUST ignore the option.

Like the RDNSS options of [RFC3646], OPTION\_RDNSS\_SELECTION MUST NOT appear in any other than the following DHCPv6 messages: Solicit, Advertise, Request, Renew, Rebind, Information-Request, and Reply.

The client SHALL periodically refresh information learned with OPTION\_RDNSS\_SELECTION. The information SHALL be refreshed on link-state changes, such as those caused by node mobility, and when renewing lifetimes of IPv6 addresses configured with DHCPv6. Additionally, the DHCPv6 Information Refresh Time Option, as specified in [RFC4242], can be used to control the update frequency.

4.3. RDNSS Selection DHCPv4 Option

The DHCPv4 option described below can be used to inform resolvers which RDNSS can be contacted when initiating forward or reverse DNS lookup procedures. This option is DNS record type agnostic and applies, for example, equally to both A and AAAA queries.

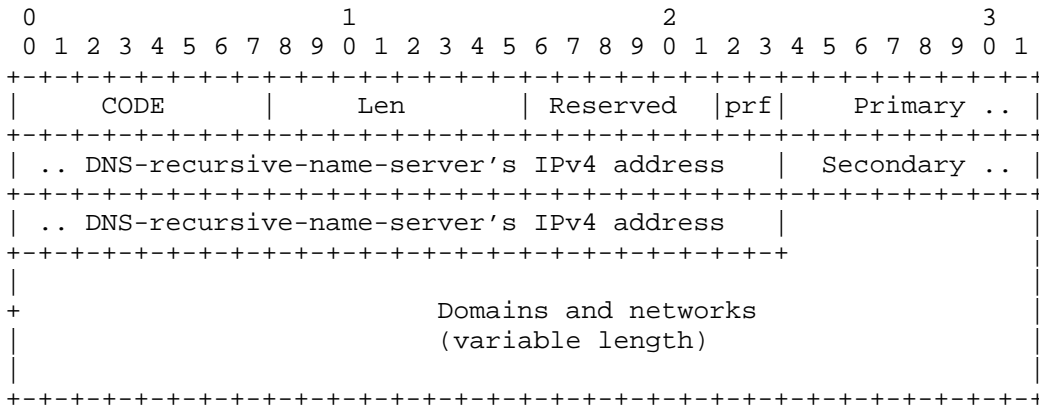

Figure 6: DHCPv4 Option for Explicit Domain Configuration

option-code: RDNSS Selection (146)

option-len: Length of the option in octets

Reserved: Field reserved for the future. MUST be set to zero and MUST be ignored on receipt.

prf: RDNSS preference:

01 High  
00 Medium  
11 Low  
10 Reserved

Reserved preference value (10) MUST NOT be sent. On receipt, the Reserved value MUST be treated as Medium preference (00).

Primary DNS-recursive-name-server's IPv4 address: Address of a primary RDNSS

Secondary DNS-recursive-name-server's IPv4 address: Address of a secondary RDNSS or 0.0.0.0 if not configured

Domains and networks: The list of domains for forward DNS lookup and networks for reverse DNS lookup about which the RDNSSes have special knowledge. Field MUST be encoded as specified in Section 8 of [RFC3315]. A special domain of "." is used to indicate capability to resolve global names and act as the default RDNSS. Lack of a "." domain on the list indicates that RDNSSes only have information related to listed domains and networks. Networks for reverse mapping are encoded as defined for IP6.ARPA [RFC3596] or IN-ADDR.ARPA [RFC2317].

The RDNSS Selection option contains one or more domains of which the primary and secondary RDNSSes have particular knowledge. If the length of the domains and networks field causes option length to exceed the maximum permissible for a single option (255 octets), then multiple options MAY be used, as described in "Encoding Long Options in the Dynamic Host Configuration Protocol (DHCPv4)" [RFC3396]. When multiple options are present, the data portions of all option instances are concatenated together.

The list of networks MUST cover all the domains configured in this option. The length of the included networks SHOULD be as long as possible to avoid potential collision with information received on other option instances or with options received from DHCP servers of other network interfaces. Overlapping networks are interpreted so that the resolver can use any of the RDNSSes for queries matching the networks.

If the RDNSS Selection option contains an RDNSS address already learned from other DHCPv4 servers of the same network and contains new domains or networks, the node SHOULD append the information to the information received earlier. The node MUST NOT remove previously obtained information. However, the node SHOULD NOT extend the lifetime of earlier information either. When a conflicting RDNSS address is learned from a less trusted interface, the node MUST ignore the option.

The client SHALL periodically refresh information learned with the RDNSS Selection option. The information SHALL be refreshed on link-state changes, such as those caused by node mobility, and when extending the lease of IPv4 addresses configured with DHCPv4.

#### 4.4. Scalability Considerations

The general size limitations of the DHCP messages limit the number of domains and networks that can be carried inside of these RDNSS selection options. The DHCP options for RDNSS selection are best suited for those deployments where relatively few and carefully selected domains and networks are enough.

#### 4.5. Limitations on Use

The RDNSS selection option SHOULD NOT be enabled by default. (In this section, "RDNSS selection option" refers to the DHCPv4 RDNSS Selection option and the DHCPv6 OPTION\_RDNSS\_SELECTION.) The option can be used in the following environments:

1. The RDNSS selection option is delivered across a secure, trusted channel.
2. The RDNSS selection option is not secured, but the client on a node does DNSSEC validation.
3. The RDNSS selection option is not secured, the resolver does DNSSEC validation, and the client communicates with the resolver configured with the RDNSS selection option over a secure, trusted channel.
4. The IP address of the RDNSS that is being recommended in the RDNSS selection option is known and trusted by the client; that is, the RDNSS selection option serves not to introduce the client to a new RDNSS, but rather to inform it that the RDNSS it has already been configured to trust is available to it for resolving certain domains.

As the DHCP by itself cannot tell whether it is using a secure, trusted channel, or whether the client on a node is performing DNSSEC validation, this option cannot be used without being explicitly enabled. The functionality can be enabled for an interface via administrative means, such as by provisioning tools or manual configuration. Furthermore, the functionality can be automatically enabled by a client on a node that knows it is performing DNSSEC validation or by a node that is configured or hard-coded to trust certain interfaces (see Section 8.2).

#### 4.6. Coexistence of Various RDNSS Configuration Tools

The DHCPv4 RDNSS Selection option and the DHCPv6 OPTION\_RDNSS\_SELECTION are designed to coexist with each other and with other tools used for RDNSS address configuration.

For RDNSS selection purposes, information received from all tools MUST be combined together into a single list, as discussed in Section 4.1.

It can happen that DHCPv4 and DHCPv6 are providing conflicting RDNSS selection information on the same or on equally trusted interfaces. In such a case, DHCPv6 MUST be preferred unless DHCPv4 is utilizing additional security frameworks for protecting the messages.

The RDNSSes learned via tools other than the DHCPv4 RDNSS Selection option and the DHCPv6 OPTION\_RDNSS\_SELECTION MUST be handled as default RDNSSes, with medium preference, when building a list of RDNSSes to talk to (see Section 4.1).

The non-exhaustive list of possible other sources for RDNSS address configuration are:

- (1) DHCPv6 OPTION\_DNS\_SERVERS defined in [RFC3646].
- (2) DHCPv4 Domain Server option defined in [RFC2132].
- (3) IPv6 Router Advertisement RDNSS Option defined in [RFC6106].

When the RDNSS selection option contains a default RDNSS address and other sources are providing RDNSS addresses, the resolver MUST make the decision about which one to prefer based on the RDNSS preference field value. If the RDNSS selection option defines medium preference, then the RDNSS from the RDNSS selection option SHALL be selected.

If multiple sources are providing same RDNSS(es) IP address(es), each address MUST be added to the RDNSS list only once.



If a node had indicated support for OPTION\_RDNSS\_SELECTION in a DHCPv6 request, the DHCPv6 server MAY omit sending of OPTION\_DNS\_SERVERS. This enables offloading use case where the network administrator wishes to only advertise low preference default RDNSSes.

#### 4.7. Considerations on Follow-Up Queries

Any follow-up queries that are performed on the basis of an answer received on an interface MUST continue to use the same interface, irrespective of the RDNSS selection settings on any other interface. For example, if a node receives a reply with a canonical name (CNAME) or delegation name (DNAME), the follow-up queries MUST be sent to RDNSS(es) of the same interface, or to the same RDNSS, irrespectively of the FQDN received. Otherwise, referrals can fail.

#### 4.8. Closing Network Interfaces and Local Caches

Cached information related to private namespaces can become obsolete after the network interface over which the information was learned is closed (Section 2.2) or a new parallel network interface is opened that alters RDNSS selection preferences. An implementation SHOULD ensure obsolete information is not retained in these events. One implementation approach to avoid unwanted/obsolete responses from the local cache is to manage per-interface DNS caches or have interface information stored in the DNS cache. An alternative approach is to perform, possibly selective, DNS cache flushing on interface change events.

### 5. Example of a Node Behavior

Figure 7 illustrates node behavior when it initializes two network interfaces for parallel usage and learns domain and network information from DHCPv6 servers.

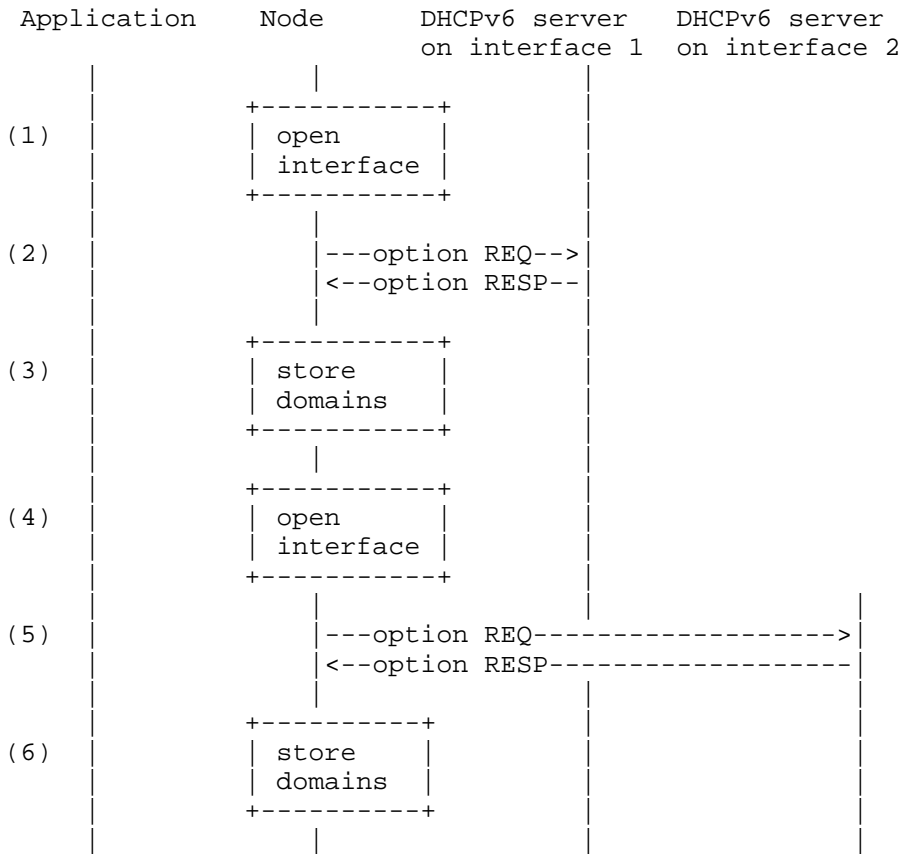

Figure 7: Illustration of Learning Domains

Flow explanations:

1. A node opens its first network interface.
2. The node obtains domain 'domain1.example.com' and IPv6 network '0.8.b.d.0.1.0.0.2.ip6.arpa' for the new interface 1 from the DHCPv6 server.
3. The node stores the learned domains and IPv6 networks for later use.
4. The node opens its second network interface 2.
5. The node obtains domain 'domain2.example.com' and IPv6 network information, say '1.8.b.d.0.1.0.0.2.ip6.arpa' for the new interface 2 from the DHCPv6 server.

6. The node stores the learned domains and networks for later use.

Figure 8 illustrates how a resolver uses the learned domain information. Network information use for reverse lookups is not illustrated, but that would be similar to the example in Figure 8.

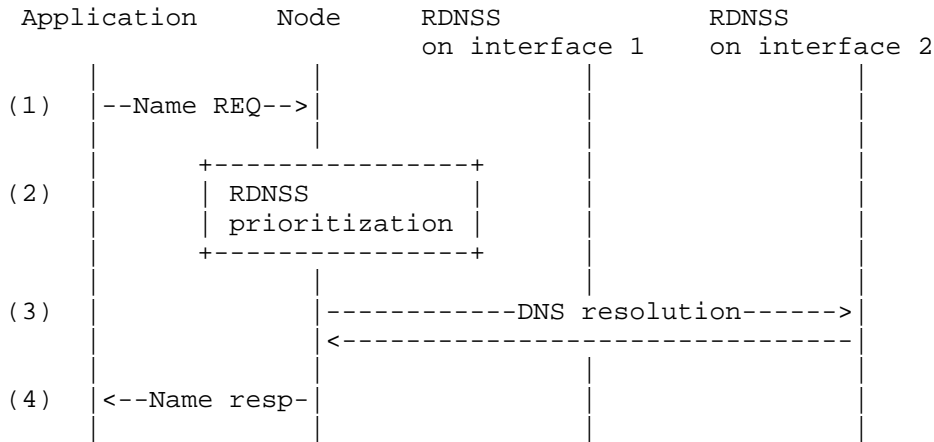

Figure 8: Example on Choosing Interface Based on Domain

Flow explanations:

1. An application makes a request for resolving an FQDN, e.g., 'private.domain2.example.com'.
2. A node creates list of RDNSSes to contact and uses configured RDNSS selection information and stored domain information on prioritization decisions.
3. The node has chosen interface 2, as it was learned earlier from DHCPv6 that the interface 2 has domain 'domain2.example.com'. The node then resolves the requested name using interface 2's RDNSS to an IPv6 address.
4. The node replies to the application with the resolved IPv6 address.

6. Considerations for Network Administrators

Network administrators deploying private namespaces can assist advanced nodes in their RDNSS selection process by providing the information described within this document.

Private namespaces MUST be globally unique in order to keep DNS unambiguous and henceforth avoid caching-related issues and destination selection problems (see Section 2.3). Exceptions to this rule are domains utilized for local name resolution (such as .local).

Private namespaces MUST only consist of subdomains of domains for which the relevant operator provides authoritative name service. Thus, subdomains of example.com are permitted in the private namespace served by an operator's RDNSSes only if the same operator provides a SOA record for example.com.

It is RECOMMENDED for administrators utilizing this tool to deploy DNSSEC for their zone in order to counter attacks against private namespaces.

## 7. IANA Considerations

Per this memo, IANA has assigned two new option codes.

The first option code has been assigned for the DHCPv4 RDNSS Selection option (146) from the "BOOTP Vendor Extensions and DHCP Options" registry in the group "Dynamic Host Configuration Protocol (DHCP) and Bootstrap Protocol (BOOTP) Parameters".

The second option code is requested to be assigned for the DHCPv6 OPTION\_RDNSS\_SELECTION (74) from the "DHCP Option Codes" registry in the group "Dynamic Host Configuration Protocol for IPv6 (DHCPv6)".

## 8. Security Considerations

### 8.1. Attack Vectors

It is possible that attackers might try to utilize the DHCPv4 RDNSS Selection option or the DHCPv6 OPTION\_RDNSS\_SELECTION option to redirect some or all DNS queries sent by a resolver to undesired destinations. The purpose of an attack might be denial of service, preparation for man-in-the-middle attack, or something akin.

Attackers might try to lure specific traffic by advertising domains and networks from very small to very large scope or simply by trying to place the attacker's RDNSS as the highest preference default RDNSS.

The best countermeasure for nodes is to implement validating DNSSEC-aware resolvers. Trusting validation done by an RDNSS is a possibility only if a node trusts the RDNSS and can use a secure channel for DNS messages.

## 8.2. Trust Levels of Network Interfaces

Trustworthiness of an interface and configuration information received over the interface is implementation and/or node deployment dependent, and the details of determining that trust are beyond the scope of this specification. Trust might, for example, be based on the nature of the interface: an authenticated and encrypted VPN, or a layer 2 connection to a trusted home network or to a trusted cellular network, might be considered trusted, while an unauthenticated and unencrypted connection to an unknown visited network would likely be considered untrusted.

In many cases, an implementation might not be able to determine trust levels without explicit configuration provided by the user or the node's administrator. Therefore, for example, an implementation might not by default trust configuration received even over VPN interfaces. In some occasions, standards defining organizations that are specific to access network technology might be able to define trust levels as part of the system design work.

## 8.3. Importance of Following the Algorithm

Section 4 uses normative language for describing a node's internal behavior in order to ensure that nodes will not open up new attack vectors by accidental use of RDNSS selection options. During the standards work, consensus was that it is safer to not always enable this option by default, but only when deemed useful and safe.

## 9. References

### 9.1. Normative References

- [RFC2119] Bradner, S., "Key words for use in RFCs to Indicate Requirement Levels", BCP 14, RFC 2119, March 1997.
- [RFC2132] Alexander, S. and R. Droms, "DHCP Options and BOOTP Vendor Extensions", RFC 2132, March 1997.
- [RFC2317] Eidnes, H., de Groot, G., and P. Vixie, "Classless IN-ADDR.ARPA delegation", BCP 20, RFC 2317, March 1998.
- [RFC3315] Droms, R., Bound, J., Volz, B., Lemon, T., Perkins, C., and M. Carney, "Dynamic Host Configuration Protocol for IPv6 (DHCPv6)", RFC 3315, July 2003.
- [RFC3396] Lemon, T. and S. Cheshire, "Encoding Long Options in the Dynamic Host Configuration Protocol (DHCPv4)", RFC 3396, November 2002.

- [RFC3596] Thomson, S., Huitema, C., Ksinant, V., and M. Souissi, "DNS Extensions to Support IP Version 6", RFC 3596, October 2003.
- [RFC4242] Venaas, S., Chown, T., and B. Volz, "Information Refresh Time Option for Dynamic Host Configuration Protocol for IPv6 (DHCPv6)", RFC 4242, November 2005.

## 9.2. Informative References

- [RFC3397] Aboba, B. and S. Cheshire, "Dynamic Host Configuration Protocol (DHCP) Domain Search Option", RFC 3397, November 2002.
- [RFC3442] Lemon, T., Cheshire, S., and B. Volz, "The Classless Static Route Option for Dynamic Host Configuration Protocol (DHCP) version 4", RFC 3442, December 2002.
- [RFC3646] Droms, R., "DNS Configuration options for Dynamic Host Configuration Protocol for IPv6 (DHCPv6)", RFC 3646, December 2003.
- [RFC4191] Draves, R. and D. Thaler, "Default Router Preferences and More-Specific Routes", RFC 4191, November 2005.
- [RFC4193] Hinden, R. and B. Haberman, "Unique Local IPv6 Unicast Addresses", RFC 4193, October 2005.
- [RFC6106] Jeong, J., Park, S., Beloeil, L., and S. Madanapalli, "IPv6 Router Advertisement Options for DNS Configuration", RFC 6106, November 2010.
- [RFC6147] Bagnulo, M., Sullivan, A., Matthews, P., and I. van Beijnum, "DNS64: DNS Extensions for Network Address Translation from IPv6 Clients to IPv4 Servers", RFC 6147, April 2011.
- [RFC6418] Blanchet, M. and P. Seite, "Multiple Interfaces and Provisioning Domains Problem Statement", RFC 6418, November 2011.
- [WITHOUT-IPV6NAT] Troan, O., Miles, D., Matsushima, S., Okimoto, T., and D. Wing, "IPv6 Multihoming without Network Address Translation", Work in Progress, February 2012.

## Appendix A. Possible Alternative Practices for RDNSS Selection

On some private namespace deployments, explicit policies for RDNSS selection are not available. This section describes ways for nodes to mitigate the problem by sending wide-spread queries and by utilizing possibly existing indirect information elements as hints.

### A.1. Sending Queries Out on Multiple Interfaces in Parallel

A possible current practice is to send DNS queries out of multiple interfaces and pick up the best out of the received responses. A node can implement DNSSEC in order to be able to reject responses that cannot be validated. Selection between legitimate answers is implementation specific, but replies from trusted RDNSSes are preferred.

A downside of this approach is increased consumption of resources, namely, power consumption if an interface, e.g., wireless, has to be brought up just for the DNS query that could have been resolved via a cheaper interface. Also, load on RDNSSes is increased. However, local caching of results mitigates these problems, and a node might also learn interfaces that seem to be able to provide 'better' responses than others and prefer those, without forgetting that fallback is required for cases when the node is connected to more than one network using private namespaces.

### A.2. Search List Option for DNS Forward Lookup Decisions

A node can learn the special domains of attached network interfaces from IPv6 Router Advertisement DNS Search List Option [RFC6106] or DHCP search list options -- DHCPv4 Domain Search Option number 119 [RFC3397] and DHCPv6 Domain Search List Option number 24 [RFC3646]. The node behavior is very similar to that illustrated in the example in Section 5. While these options are not intended to be used in RDNSS selection, they can be used by the nodes as hints for smarter RDNSS prioritization purposes in order to increase likelihood of fast and successful DNS queries.

Overloading of existing DNS search list options is not without problems: resolvers would obviously use the domains learned from search lists for name resolution purposes. This might not be a problem in deployments where DNS search list options contain few domains like 'example.com, private.example.com' but can become a problem if many domains are configured.

### A.3. More-Specific Routes for Reverse Lookup Decisions

[RFC4191] defines how more-specific routes can be provisioned for nodes. This information is not intended to be used in RDNSS selection, but nevertheless, a node can use this information as a hint about which interface would be best to try first for reverse lookup procedures. An RDNSS configured via the same interface as more-specific routes is more likely capable to answer reverse lookup questions correctly than an RDNSS of another interface. The likelihood of success is possibly higher if an RDNSS address is received in the same RA [RFC6106] as the more-specific route information.

### A.4. Longest Matching Prefix for Reverse Lookup Decisions

A node can utilize the longest matching prefix approach when deciding which RDNSS to contact for reverse lookup purposes. Namely, the node can send a DNS query to an RDNSS learned over an interface having a longest matching prefix to the address being queried. This approach can help in cases where Unique Local Addressing (ULA) [RFC4193] addresses are used and when the queried address belongs to a node or server within the same network (for example, intranet).

### Appendix B. DNSSEC and Multiple Answers Validating with Different Trust Anchors

When validating DNS answers with DNSSEC, a validator might order the list of trust anchors it uses to start validation chains, in the order of the node's preferences for those trust anchors. A node could use this ability in order to select among alternative DNS results from different interfaces. Suppose that a node has a trust anchor for the public DNS root and also has a special-purpose trust anchor for example.com. An answer is received on interface i1 for www.example.com, and the validation for that succeeds by using the public trust anchor. Also, an answer is received on interface i2 for www.example.com, and the validation for that succeeds by using the trust anchor for example.com. In this case, the node has evidence for relying on i2 for answers in the example.com zone.

### Appendix C. Pseudocode for RDNSS Selection

This section illustrates the RDNSS selection logic in C-style pseudocode. The code is not intended to be usable as such; it is only here for illustration purposes.

The beginning of the whole procedure is a call to "dns\_query" function with a query and list of RDNSSes given as parameters.



```
/* This is a structure that holds all information related to an RDNSS.*/
/* Here we include only the information related for this illustration.*/
struct rdNSS
{
    int prf;          /* Preference of an RDNSS. */
    int interface;   /* Type of an interface RDNSS was learned over. */
    struct d_and_n; /* Domains and networks information for this RDNSS. */
};

int has_special_knowledge( const struct rdNSS *rdNSS,
                          const char *query)
{
    /* This function matches the query to the domains and networks
       information of the given RDNSS. The function returns TRUE
       if the query matches the domains and networks; otherwise, FALSE. */

    /* The implementation of this matching function
       is left for reader, or rather writer. */

    /* return TRUE if query matches rdNSS->d_and_n, otherwise FALSE. */
}

const struct rdNSS* compare_rdNSS_prf( const struct rdNSS *rdNSS_1,
                                       const struct rdNSS *rdNSS_2 )
{
    /* This function compares preference values of two RDNSSes and
       returns the more preferred RDNSS. The function prefers rdNSS_1
       in the case of equal preference values. */

    if (rdNSS_1->prf == HIGH_PRF) return rdNSS_1;
    if (rdNSS_2->prf == HIGH_PRF) return rdNSS_2;
    if (rdNSS_1->prf == MED_PRF) return rdNSS_1;
    if (rdNSS_2->prf == MED_PRF) return rdNSS_2;
    return rdNSS_1;
}

const struct rdNSS* compare_rdNSS_trust( const struct rdNSS *rdNSS_1,
                                         const struct rdNSS *rdNSS_2 )
{
    /* This function compares trust of the two given RDNSSes. The trust
       is based on the trust on the interface RDNSS was learned on. */

    /* If the interface is the same, the trust is also the same,
       and hence, function will return NULL to indicate lack of
       difference in trust. */

    if (rdNSS_1->interface == rdNSS_2->interface) return NULL;
}
```

```

/* Otherwise, implementation-specific rules define which interface
   is considered more secure than the other. The rules shown here
   are only for illustrative purposes and must be overwritten by
   real implementations. */

if (rdnss_1->interface == IF_VPN) return rdnss_1;
if (rdnss_2->interface == IF_VPN) return rdnss_2;
if (rdnss_1->interface == IF_CELLULAR) return rdnss_1;
if (rdnss_2->interface == IF_CELLULAR) return rdnss_2;
if (rdnss_1->interface == IF_WLAN) return rdnss_1;
if (rdnss_2->interface == IF_WLAN) return rdnss_2;

/* Both RDNSSes are from unknown interfaces, so return NULL as
   trust-based comparison is impossible. */
return NULL;
}

int compare_rdnsses ( const struct rdnss *rdnss_1,
                    const struct rdnss *rdnss_2,
                    const char *query)
{
/* This function compares two RDNSSes and decides which one is more
   preferred for resolving the query. If the rdnss_1 is more
   preferred, the function returns TRUE; otherwise, FALSE. */

const struct rdnss *more_trusted_rdnss = NULL;
const struct rdnss *less_trusted_rdnss = NULL;

/* Find out if either RDNSS is more trusted. */
more_trusted_rdnss = compare_rdnss_trust( rdnss_1, rdnss_2 );

/* Check if either was more trusted. */
if (more_trusted_rdnss)
{

/* Check which RDNSS was less trusted. */
less_trusted_rdnss =
    more_trusted_rdnss == rdnss_1 ? rdnss_2 : rdnss_1;

/* If the more trusted interface is not of low preference
   or has special knowledge about the query, or the more
   trusted is more preferred and the less trusted has no special
   information, prefer more trusted. Otherwise, prefer less trusted. */
if (more_trusted_rdnss->prf != LOW_PRF ||
    has_special_knowledge( more_trusted_rdnss, query ) ||
    (compare_rdnss_prf( more_trusted_rdnss, less_trusted_rdnss)
     == more_trusted_rdnss &&
     !has_special_knowledge( less_trusted_rdnss, query)))

```

```

    {
/* If the more_trusted_rdnss was rdnss_1, return TRUE.          */
    return more_trusted_rdnss == rdnss_1 ? TRUE : FALSE;
    }
    else
    {
/* If the more_trusted_rdnss was rdnss_1, return TRUE.          */
    return less_trusted_rdnss == rdnss_1 ? TRUE : FALSE;
    }
}
else
{
/* There is no trust difference between RDNSSes; therefore, prefer the
   RDNSS that has special knowledge.  If both have specific knowledge,
   then prefer the rdnss_1.                                     */
    if (has_special_knowledge( rdnss_1, query )) return TRUE;
    if (has_special_knowledge( rdnss_2, query )) return FALSE;

/* Neither had special knowledge.  Therefore, return TRUE if
   rdnss_1 is more preferred; otherwise, return FALSE          */
    return compare_rdnss_prf( rdnss_1 , rdnss_2 )
        == rdnss_1 ? TRUE : FALSE;
}
}

void bubble_sort_rdnsses( struct rdnss rdnss_list[],
                          const int rdnsses,
                          const char* query)
{
/* This function implements a bubble sort to arrange
   RDNSSes in rdnss_list into preference order.                */

    int i;
    int swapped = 0;
    struct rdnss rdnss_swap;

    do
    {
/* Clear swapped-indicator.                                     */
        swapped = FALSE;

/* Go through the RDNSS list.                                   */
        for (i = 0; i < rdnsses-1; i++)
        {
/* Check if the next two items are in the right order, i.e.,
   more preferred before less preferred.                        */
            if (compare_rdnsses( &rdnss_list[i],
                                &rdnss_list[i+1], query) == FALSE)

```

```

    {
/* The order between two was not right, so swap these two RDNSSes. */
        rdNSS_swap = rdNSS_list[i];
        rdNSS_list[i] = rdNSS_list[i+1];
        rdNSS_list[i+1] = rdNSS_swap;
        swapped = TRUE;
    }
} while (swapped);

/* No more swaps, which means the rdNSS_list is now sorted
into preference order. */
}

struct hostent *dns_query( struct rdNSS rdNSS_list[],
                          const int rdNSSes,
                          const char* query )
{
/* Perform address resolution for the query. */
    int i;
    struct hostent response;

/* Sort the RDNSSes into preference order. */
/* This is the function with which this pseudocode starts. */
    bubble_sort_rdnsses( &rdNSS_list[0], rdNSSes, query );

/* Go through all RDNSSes or until valid response is found. */
    for (i = 0; i < rdNSSes; i++)
    {
/* Use the highest preference RDNSS first. */
        response = send_and_validate_dns_query( rdNSS_list[i], query);

/* Check if DNSSEC validation is in use, and if so, validate the
received response. */
        if (dnssec_in_use)
        {
            response = dnssec_validate(response);
        }

/* If response is validated, use that. Otherwise, proceed to next
RDNSS. */
        if (response) return response;
        else continue;
    }

/* If acceptable response has been found, return it. */
    if (response) return response;
}

```

```
    return NULL;  
}
```

#### Appendix D. Acknowledgements

The authors would like to thank the following people for their valuable feedback and improvement ideas: Mark Andrews, Jari Arkko, Marcelo Bagnulo, Brian Carpenter, Stuart Cheshire, Lars Eggert, Stephan Farrell, Tomohiro Fujisaki, Brian Haberman, Peter Koch, Suresh Krishnan, Murray Kucherawy, Barry Leiba, Edward Lewis, Kurtis Lindqvist, Arifumi Matsumoto, Erik Nordmark, Steve Padgett, Fabien Rapin, Matthew Ryan, Robert Sparks, Dave Thaler, Sean Turner, Margaret Wasserman, Dan Wing, and Dec Wojciech. Ted Lemon and Julien Laganier receive special thanks for their contributions to security considerations.

#### Authors' Addresses

Teemu Savolainen  
Nokia  
Hermiankatu 12 D  
Tampere FI-33720  
Finland

EMail: teemu.savolainen@nokia.com

Jun-ya Kato  
NTT  
9-11, Midori-Cho 3-Chome Musashino-Shi  
Tokyo 180-8585  
Japan

EMail: kato@syce.net

Ted Lemon  
Nominum, Inc.  
2000 Seaport Boulevard  
Redwood City, CA 94063  
USA

Phone: +1 650 381 6000

EMail: Ted.Lemon@nominum.com

