

Internet Engineering Task Force (IETF)
Request for Comments: 6073
Category: Standards Track
ISSN: 2070-1721

L. Martini
C. Metz
Cisco Systems, Inc.
T. Nadeau
LucidVision
M. Bocci
M. Aissaoui
Alcatel-Lucent
January 2011

Segmented Pseudowire

Abstract

This document describes how to connect pseudowires (PWs) between different Packet Switched Network (PSN) domains or between two or more distinct PW control plane domains, where a control plane domain uses a common control plane protocol or instance of that protocol for a given PW. The different PW control plane domains may belong to independent autonomous systems, or the PSN technology is heterogeneous, or a PW might need to be aggregated at a specific PSN point. The PW packet data units are simply switched from one PW to another without changing the PW payload.

Status of This Memo

This is an Internet Standards Track document.

This document is a product of the Internet Engineering Task Force (IETF). It represents the consensus of the IETF community. It has received public review and has been approved for publication by the Internet Engineering Steering Group (IESG). Further information on Internet Standards is available in Section 2 of RFC 5741.

Information about the current status of this document, any errata, and how to provide feedback on it may be obtained at <http://www.rfc-editor.org/info/rfc6073>.

Copyright Notice

Copyright (c) 2011 IETF Trust and the persons identified as the document authors. All rights reserved.

This document is subject to BCP 78 and the IETF Trust's Legal Provisions Relating to IETF Documents (<http://trustee.ietf.org/license-info>) in effect on the date of publication of this document. Please review these documents carefully, as they describe your rights and restrictions with respect to this document. Code Components extracted from this document must include Simplified BSD License text as described in Section 4.e of the Trust Legal Provisions and are provided without warranty as described in the Simplified BSD License.

This document may contain material from IETF Documents or IETF Contributions published or made publicly available before November 10, 2008. The person(s) controlling the copyright in some of this material may not have granted the IETF Trust the right to allow modifications of such material outside the IETF Standards Process. Without obtaining an adequate license from the person(s) controlling the copyright in such materials, this document may not be modified outside the IETF Standards Process, and derivative works of it may not be created outside the IETF Standards Process, except to format it for publication as an RFC or to translate it into languages other than English.

Table of Contents

1. Introduction	4
2. Specification of Requirements	5
3. Terminology	5
4. General Description	6
5. PW Switching and Attachment Circuit Type	9
6. Applicability	9
7. MPLS-PW to MPLS-PW Switching	10
7.1. Static Control Plane Switching	10
7.2. Two LDP Control Planes Using the Same FEC Type	11
7.2.1. FEC 129 Active/Passive T-PE Election Procedure	11
7.3. LDP Using FEC 128 to LDP Using the Generalized FEC 129	12
7.4. LDP SP-PE TLV	12
7.4.1. PW Switching Point PE Sub-TLVs	14
7.4.2. Adaptation of Interface Parameters	15
7.5. Group ID	16
7.6. PW Loop Detection	16
8. MPLS-PW to L2TPv3-PW Control Plane Switching	16
8.1. Static MPLS and L2TPv3 PWs	17
8.2. Static MPLS PW and Dynamic L2TPv3 PW	17

8.3.	Static L2TPv3 PW and Dynamic LDP/MPLS PW	17
8.4.	Dynamic LDP/MPLS and L2TPv3 PWs	17
8.4.1.	Session Establishment	18
8.4.2.	Adaptation of PW Status message	18
8.4.3.	Session Tear Down	18
8.5.	Adaptation of L2TPv3 AVPs to Interface Parameters	19
8.6.	Switching Point TLV in L2TPv3	20
8.7.	L2TPv3 and MPLS PW Data Plane	20
8.7.1.	Mapping the MPLS Control Word to L2TP	21
9.	Operations, Administration, and Maintenance (OAM)	22
9.1.	Extensions to VCCV to Support MS-PWs	22
9.2.	OAM from MPLS PW to L2TPv3 PW	22
9.3.	OAM Data Plane Indication from MPLS PW to MPLS PW	22
9.4.	Signaling OAM Capabilities for Switched Pseudowires	23
9.5.	OAM Capability for MS-PWs Demultiplexed Using MPLS	23
9.5.1.	MS-PW and VCCV CC Type 1	24
9.5.2.	MS-PW and VCCV CC Type 2	24
9.5.3.	MS-PW and VCCV CC Type 3	24
9.6.	MS-PW VCCV Operations	24
9.6.1.	VCCV Echo Message Processing	25
9.6.2.	Detailed VCCV Procedures	27
10.	Mapping Switched Pseudowire Status	31
10.1.	PW Status Messages Initiated by the S-PE	32
10.1.1.	Local PW2 Transmit Direction Fault	33
10.1.2.	Local PW1 Transmit Direction Fault	34
10.1.3.	Local PW2 Receive Direction Fault	34
10.1.4.	Local PW1 Receive Direction Fault	34
10.1.5.	Clearing Faults	34
10.2.	PW Status Messages and SP-PE TLV Processing	35
10.3.	T-PE Processing of PW Status Messages	35
10.4.	Pseudowire Status Negotiation Procedures	35
10.5.	Status Dampening	35
11.	Peering between Autonomous Systems	35
12.	Congestion Considerations	36
13.	Security Considerations	36
13.1.	Data Plane Security	36
13.1.1.	VCCV Security Considerations	36
13.2.	Control Protocol Security	37
14.	IANA Considerations	38
14.1.	L2TPv3 AVP	38
14.2.	LDP TLV TYPE	38
14.3.	LDP Status Codes	38
14.4.	L2TPv3 Result Codes	38
14.5.	New IANA Registries	39
15.	Normative References	39
16.	Informative References	40
17.	Acknowledgments	42
18.	Contributors	42

1. Introduction

The PWE3 Architecture [RFC3985] defines the signaling and encapsulation techniques for establishing Single-Segment Pseudowires (SS-PWs) between a pair of terminating PEs. Multi-Segment Pseudowires (MS-PWs) are most useful in two general cases:

- i. In some cases it is not possible, desirable, or feasible to establish a PW control channel between the terminating source and destination PEs. At a minimum, PW control channel establishment requires knowledge of and reachability to the remote (terminating) PE IP address. The local (terminating) PE may not have access to this information because of topology, operational, or security constraints.

An example is the inter-AS L2VPN scenario where the terminating PEs reside in different provider networks (ASes) and it is the practice to cryptographically sign all control traffic exchanged between two networks. Technically, an SS-PW could be used but this would require cryptographic signatures on ALL terminating source and destination PE nodes. An MS-PW allows the providers to confine key administration to just the PW switching points connecting the two domains.

A second example might involve a single AS where the PW setup path between the terminating PEs is computed by an external entity. Assume that a full mesh of PWE3 control channels is established between PE-A, PE-B, and PE-C. A client-layer L2 connection tunneled through a PW is required between terminating PE-A and PE-C. The external entity computes a PW setup path that passes through PE-B. This results in two discrete PW segments being built: one between PE-A and PE-B and one between PE-B and PE-C. The successful client-layer L2 connection between terminating PE-A and terminating PE-C requires that PE-B performs the PWE3 switching process.

A third example involves the use of PWs in hierarchical IP/MPLS networks. Access networks connected to a backbone use PWs to transport customer payloads between customer sites serviced by the same access network and up to the edge of the backbone where they can be terminated or switched onto a succeeding PW segment crossing the backbone. The use of PWE3 switching between the access and backbone networks can potentially reduce the PWE3 control channels and routing information processed by the access network T-PEs.

It should be noted that PWE3 switching does not help in any way to reduce the amount of PW state supported by each access network T-PE.

- ii. In some applications, the signaling protocol and encapsulation on each segment of the PW are different. The terminating PEs are connected to networks employing different PW signaling and encapsulation protocols. In this case, it is not possible to use an SS-PW. An MS-PW with the appropriate signaling protocol interworking performed at the PW switching points can enable PW connectivity between the terminating PEs in this scenario.

A more detailed discussion of the requirements pertaining to MS-PWs can be found in [RFC5254].

There are four different mechanisms to establish PWs:

- i. Static configuration of the PW (MPLS or Layer 2 Tunneling Protocol version 3 (L2TPv3))
- ii. LDP using FEC 128 (Pwid FEC Element)
- iii. LDP using FEC 129 (Generalized Pwid FEC Element)
- iv. L2TPv3

While MS-PWs are composed of PW segments, each PW segment cannot function independently, as the PW service is always instantiated across the complete MS-PW. Hence, no PW segments can be signaled or be operational without the complete MS-PW being signaled at once.

2. Specification of Requirements

The key words "MUST", "MUST NOT", "REQUIRED", "SHALL", "SHALL NOT", "SHOULD", "SHOULD NOT", "RECOMMENDED", "MAY", and "OPTIONAL" in this document are to be interpreted as described in [RFC2119].

3. Terminology

- PW Terminating Provider Edge (T-PE). A PE where the customer-facing attachment circuits (ACs) are bound to a PW forwarder. A Terminating PE is present in the first and last segments of a MS-PW. This incorporates the functionality of a PE as defined in [RFC3985].
- Single-Segment Pseudowire (SS-PW). A PW set up directly between two T-PE devices. The PW label is unchanged between the originating and terminating T-PEs.

- Multi-Segment Pseudowire (MS-PW). A static or dynamically configured set of two or more contiguous PW segments that behave and function as a single point-to-point PW. Each end of an MS-PW by definition MUST terminate on a T-PE.
- PW Segment. A part of a single-segment or multi-segment PW, which traverses one PSN tunnel in each direction between two PE devices, T-PEs and/or S-PEs (switching PE).
- PW Switching Provider Edge (S-PE). A PE capable of switching the control and data planes of the preceding and succeeding PW segments in an MS-PW. The S-PE terminates the PSN tunnels of the preceding and succeeding segments of the MS-PW. It therefore includes a PW switching point for an MS-PW. A PW switching point is never the S-PE and the T-PE for the same MS-PW. A PW switching point runs necessary protocols to set up and manage PW segments with other PW switching points and terminating PEs. An S-PE can exist anywhere a PW must be processed or policy applied. It is therefore not limited to the edge of a provider network.
- MS-PW path. The set of S-PEs that will be traversed in sequence to form the MS-PW.

4. General Description

A pseudowire (PW) is a mechanism that carries the essential elements of an emulated service from one PE to one or more other PEs over a PSN as described in Figure 1 and in [RFC3985]. Many providers have deployed PWs as a means of migrating existing (or building new) L2VPN services (e.g., Frame Relay, ATM, or Ethernet) onto a PSN.

PWs may span multiple domains of the same or different provider networks. In these scenarios, PW control channels (i.e., targeted LDP, L2TPv3) and PWs will cross AS boundaries.

Inter-AS L2VPN functionality is currently supported, and several techniques employing MPLS encapsulation and LDP signaling have been documented [RFC4364]. It is also straightforward to support the same inter-AS L2VPN functionality employing L2TPv3. In this document, we define a methodology to switch a PW between different Packet Switched Network (PSN) domains or between two or more distinct PW control plane domains.

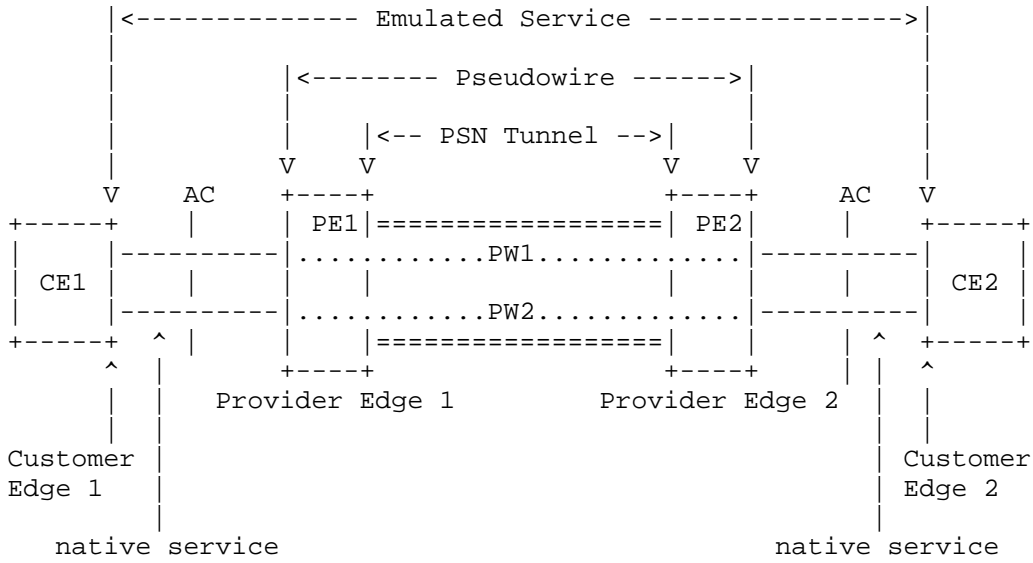

Figure 1: PWE3 Reference Model

There are two methods for switching a PW between two PW domains. In the first method (Figure 2), the two separate control plane domains terminate on different PEs.

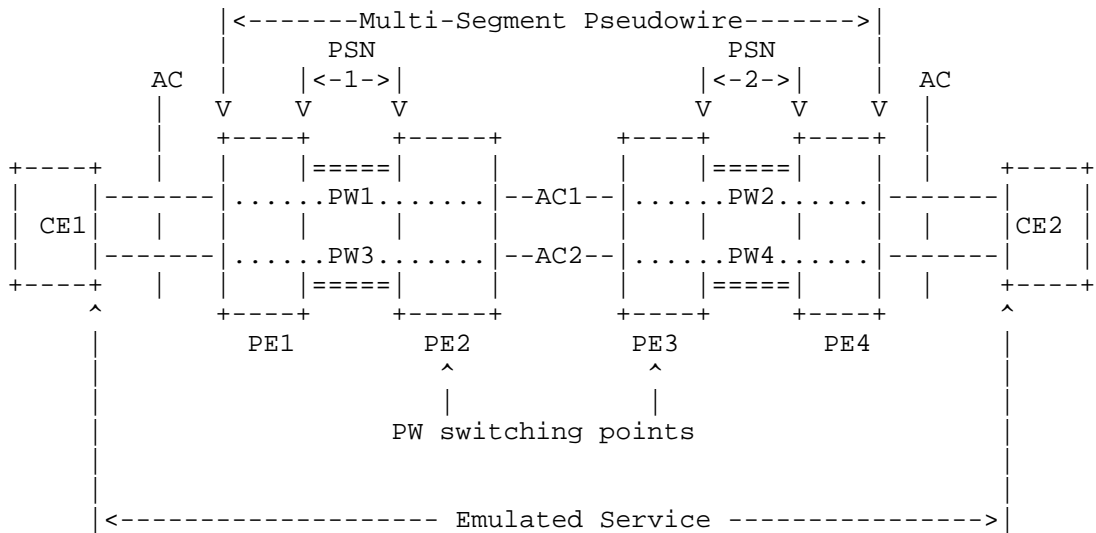

Figure 2: PW Switching Using AC Reference Model

In Figure 2, pseudowires in two separate PSNs are stitched together using native service attachment circuits. PE2 and PE3 only run the control plane for the PSN to which they are directly attached. At PE2 and PE3, PW1 and PW2 are connected using attachment circuit AC1, while PW3 and PW4 are connected using attachment circuit AC2.

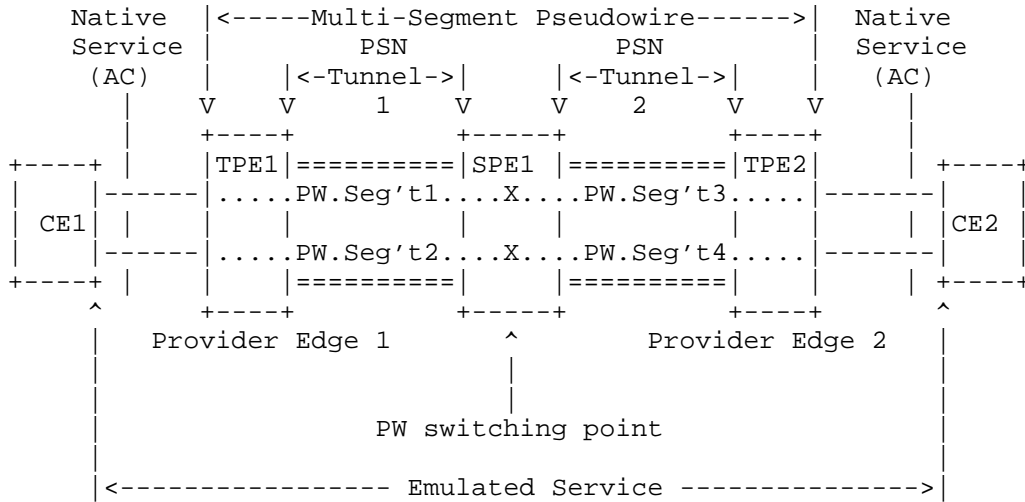

Figure 3: MS-PW Reference Model

In Figure 3, SPE1 runs two separate control planes: one toward TPE1, and one toward TPE2. The PW switching point (S-PE) is configured to connect PW Segment 1 and PW Segment 3 together to complete the multi-segment PW between TPE1 and TPE2. PW Segment 1 and PW Segment 3 MUST be of the same PW type, but PSN Tunnel 1 and PSN Tunnel 2 need not be the same technology. In the latter case, if the PW is switched to a different technology, the PEs must adapt the PDU encapsulation between the different PSN technologies. In the case where PSN Tunnel 1 and PSN Tunnel 2 are the same technology, the PW PDU does not need to be modified, and PDUs are then switched between the pseudowires at the PW label level.

It should be noted that it is possible to adapt one PSN technology to a different one, for example, MPLS over an IP encapsulation or Generic Routing Encapsulation (GRE) [RFC4023], but this is outside the scope of this document. Further, one could perform an interworking function on the PWs themselves at the S-PE, allowing conversion from one PW type to another, but this is also outside the scope of this document.

This document describes procedures for building multi-segment pseudowires using manual configuration of the switching point PE1.

Other documents may build on this base specification to automate the configuration and selection of S-PE1. All elements of the establishment of end-to-end MS-PWs including routing and signaling are out of scope of this document, and any discussion in this document serves purely as examples. It should also be noted that a PW can traverse multiple PW switching points along its path, and the edge PEs will not require any specific knowledge of how many S-PEs the PW has traversed (though this may be reported for troubleshooting purposes).

The general approach taken for MS-PWs is to connect the individual control planes by passing along any signaling information immediately upon reception. First, the S-PE is configured to switch a PW segment from a specific peer to another PW segment destined for a different peer. No control messages are exchanged yet, as the S-PE does not have enough information to actually initiate the PW setup messages. However, if a session does not already exist, a control protocol (LDP/L2TP) session MAY be setup. In this model, the MS-PW setup is starting from the T-PE devices. Once the T-PE is configured, it sends the PW control setup messages. These messages are received by the S-PE, and immediately used to form the PW setup messages for the next SS-PW of the MS-PW.

5. PW Switching and Attachment Circuit Type

The PWs in each PSN are established independently, with each PSN being treated as a separate PW domain. For example, in Figure 2 for the case of MPLS PSNs, PW1 is setup between PE1 and PE2 using the LDP targeted session as described in [RFC4447], and at the same time a separate pseudowire, PW2, is setup between PE3 and PE4. The ACs for PW1 and PW2 at PE2 and PE3 MUST be configured such that they are the same PW type, e.g., ATM Virtual Channel Connection (VCC), Ethernet VLAN, etc.

6. Applicability

The general applicability of MS-PWs and their relationship to L2VPNs are described in [RFC5659]. The applicability of a PW type, as specified in the relevant RFC for that encapsulation (e.g., [RFC4717] for ATM), applies to each segment. This section describes further applicability considerations.

As with SS-PWs, the performance of any segment will be limited by the performance of the underlying PSN. The performance may be further degraded by the emulation process, and performance degradation may be further increased by traversing multiple PW segments. Furthermore, the overall performance of an MS-PW is no better than the worst-performing segment of that MS-PW.

Since different PSN types may be able to achieve different maximum performance objectives, it is necessary to carefully consider which PSN types are used along the path of an MS-PW.

7. MPLS-PW to MPLS-PW Switching

Referencing Figure 3, T-PE1 set up PW Segment 1 using the LDP targeted session as described in [RFC4447], at the same time a separate pseudowire, PW Segment 3, is setup to T-PE2. Each PW is configured independently on the PEs, but on S-PE1, PW Segment 1 is connected to PW Segment 3. PDUs are then switched between the pseudowires at the PW label level. Hence, the data plane does not need any special knowledge of the specific pseudowire type. A simple standard MPLS label swap operation is sufficient to connect the two PWs, and in this case the PW adaptation function cannot be used. However, when pushing a new PSN label, the Time to Live (TTL) SHOULD be set to 255, or some other locally configured fixed value.

This process can be repeated as many times as necessary; the only limitation to the number of S-PEs traversed is imposed by the TTL field of the PW MPLS label. The setting of the TTL of the PW MPLS label is a matter of local policy on the originating PE, but SHOULD be set to 255. However, if the PW PDU contains an Operations, Administration, and Maintenance (OAM) packet, then the TTL can be set to the required value as explained later in this document.

There are three different mechanisms for MPLS-to-MPLS PW setup:

- i. Static configuration of the PW
- ii. LDP using FEC 128
- iii. LDP using the generalized FEC 129

This results in four distinct PW switching situations that are significantly different and must be considered in detail:

- i. Switching between two static control planes
- ii. Switching between a static and a dynamic LDP control plane
- iii. Switching between two LDP control planes using the same FEC type
- iv. Switching between LDP using FEC 128 and LDP using the generalized FEC 129

7.1. Static Control Plane Switching

In the case of two static control planes, the S-PE MUST be configured to direct the MPLS packets from one PW into the other. There is no control protocol involved in this case. When one of the control planes is a simple static PW configuration and the other control

plane is a dynamic LDP FEC 128 or generalized PW FEC, then the static control plane should be considered similar to an attachment circuit (AC) in the reference model of Figure 1. The switching point PE SHOULD signal the appropriate PW status if it detects a failure in sending or receiving packets over the static PW segment. In the absence of a PW status communication mechanism when the PW is statically configured, the status communicated to the dynamic LDP PW will be limited to local interface failures. In this case, the S-PE PE behaves in a very similar manner to a T-PE, assuming an active signaling role. This means that the S-PE will immediately send the LDP Label Mapping message if the static PW is deemed to be UP.

7.2. Two LDP Control Planes Using the Same FEC Type

The S-PE SHOULD assume an initial passive role. This means that when independent PWs are configured on the switching point, the Label Switching Router (LSR) does not advertise the LDP PW FEC mapping until it has received at least one of the two PW LDP FECs from a remote PE. This is necessary because the switching point LSR does not know a priori what the interface parameter field in the initial FEC advertisement will contain.

If one of the S-PEs doesn't accept an LDP Label Mapping message, then a Label Release message may be sent back to the originator T-PE depending on the cause of the error. LDP liberal label retention mode still applies; hence, if a PE is simply not configured yet, the label mapping is stored for future use. An MS-PW is declared UP only when all the constituent SS-PWs are UP.

The Pseudowire Identifier (PWid), as defined in [RFC4447], is a unique number between each pair of PEs. Hence, each SS-PW that forms an MS-PW may have a different PWid. In the case of the generalized PW FEC, the Attachment Group Identifier (AGI) / Source Attachment Identifier (SAI) / Target Attachment Identifier (TAI) may have to also be different for some, or sometimes all, SS-PWs.

7.2.1. FEC 129 Active/Passive T-PE Election Procedure

When an MS-PW is signaled using FEC 129, each T-PE might independently start signaling the MS-PW. If the MS-PW path is not statically configured, in certain cases the signaling procedure could result in an attempt to set up each direction of the MS-PW through different S-PEs. If an operator wishes to avoid this situation, one of the T-PEs MUST start the PW signaling (active role), while the other waits to receive the LDP label mapping before sending the respective PW LDP Label Mapping message (passive role). When the MS-PW path is not statically configured, the active T-PE (the Source

T-PE) and the passive T-PE (the Target T-PE) MUST be identified before signaling is initiated for a given MS-PW.

The determination of which T-PE assumes the active role SHOULD be done as follows:

The SAI and TAI are compared as unsigned integers; if the SAI is larger, then the T-PE assumes the active role.

The selection process to determine which T-PE assumes the active role MAY be superseded by manual provisioning. In this case, one of the T-PEs MUST be set to the active role, and the other one MUST be set to the passive role.

7.3. LDP Using FEC 128 to LDP Using the Generalized FEC 129

When a PE is using the generalized FEC 129, there are two distinct roles that a PE can assume: active and passive. A PE that assumes the active role will send the LDP PW setup message, while a passive role PE will simply reply to an incoming LDP PW setup message. The S-PE will always remain passive until a PWid FEC 128 LDP message is received, which will cause the corresponding generalized PW FEC LDP message to be formed and sent. If a generalized FEC PW LDP message is received while the switching point PE is in a passive role, the corresponding PW FEC 128 LDP message will be formed and sent.

PWids need to be mapped to the corresponding AGI/TAI/SAI and vice versa. This can be accomplished by local S-PE configuration, or by some other means, such as some form of auto discovery. Such other means are outside the scope of this document.

7.4. LDP SP-PE TLV

The edge-to-edge PW might traverse several switching points, in separate administrative domains. For management and troubleshooting reasons, it is useful to record information about the switching points at the S-PEs that the PW traverses. This is accomplished by using a PW Switching Point PE TLV (SP-PE TLV).

Sending the SP-PE TLV is OPTIONAL; however, the PE or S-PE MUST process the TLV upon reception. The "U" bit MUST be set for backward compatibility with T-PEs that do not support the MS-PW extensions described in the document. The SP-PE TLV MAY appear only once for each switching point traversed, and it cannot be of length zero. The SP-PE TLV is appended to the PW FEC at each S-PE, and the order of the SP-PE TLVs in the LDP message MUST be preserved. The SP-PE TLV

is necessary to support some of the Virtual Circuit Connectivity Verification (VCCV) functions for MS-PWs. See Section 9.5 for more details. The SP-PE TLV is encoded as follows:

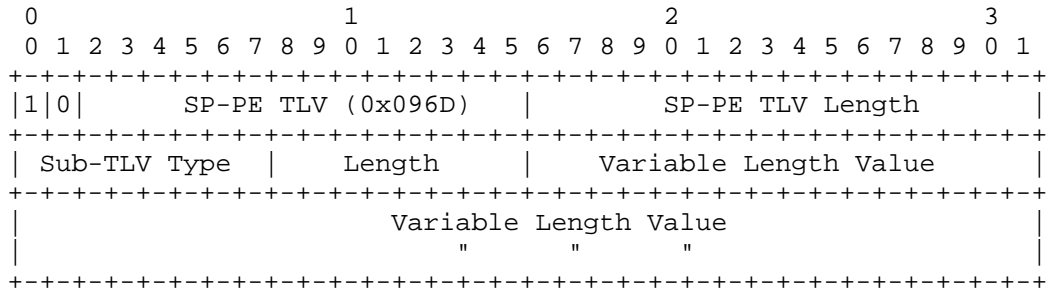

- SP-PE TLV Length

Specifies the total length of all the following SP-PE TLV fields in octets.

- Sub-TLV Type

Encodes how the Value field is to be interpreted.

- Length

Specifies the length of the Value field in octets.

- Value

Octet string of Length octets that encodes information to be interpreted as specified by the Type field.

PW Switching Point PE sub-TLV Types are assigned by IANA according to the process defined in Section 14 (IANA Considerations) below.

For local policy reasons, a particular S-PE can filter out all SP-PE TLVs in a Label Mapping message that traverses it and not include its own SP-PE TLV. In this case, from any upstream PE, it will appear as if this particular S-PE is the T-PE. This might be necessary, depending on local policy, if the S-PE is at the service provider administrative boundary. It should also be noted that because there are no SP-PE TLVs describing the path beyond the S-PE that removed them, VCCV will only work as far as that S-PE.

7.4.1. PW Switching Point PE Sub-TLVs

The SP-PE TLV contains sub-TLVs that describe various characteristics of the S-PE traversed. The SP-PE TLV MUST contain the appropriate mandatory sub-TLVs specified below. The definitions of the PW Switching Point PE sub-TLVs are as follows:

- Pwid of last PW segment traversed.

This is only applicable if the last PW segment traversed used LDP FEC 128 to signal the PW. This sub-TLV type contains a Pwid in the format of the Pwid described in [RFC4447]. This is just a 32-bit unsigned integer number.

- PW Switching Point description string.

An OPTIONAL description string of text up to 80 characters long. Human-readable text MUST be provided in the UTF-8 character set using the Default Language [RFC2277].

- Local IP address of PW Switching Point.

The local IPv4 or IPv6 address of the PW Switching Point. This is an OPTIONAL Sub-TLV. In most cases, this will be the local LDP session IP address of the S-PE.

- Remote IP address of the last PW Switching Point traversed or of the T-PE.

The IPv4 or IPv6 address of the last PW Switching Point traversed or of the T-PE. This is an OPTIONAL Sub-TLV. In most cases, this will be the remote IP address of the LDP session. This Sub-TLV SHOULD only be included if there are no other SP-PE TLVs present from other S-PEs, or if the remote IP address of the LDP session does not correspond to the "Local IP address of PW Switching Point" TLV value contained in the last SP-PE TLV.

- The FEC element of last PW segment traversed.

This is only applicable if the last PW segment traversed used LDP FEC 129 to signal the PW.

The FEC element of the last PW segment traversed. This is encoded in the following format:

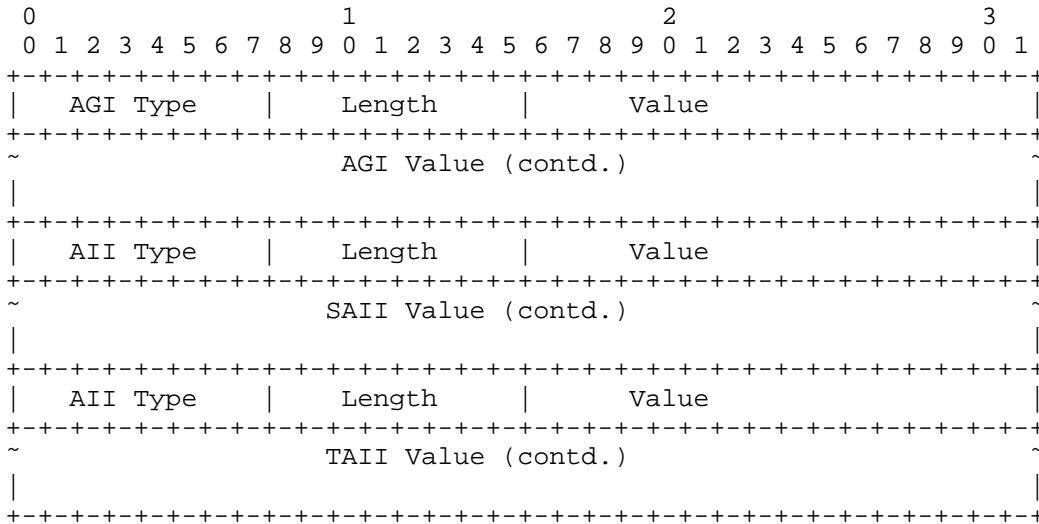

- L2 PW address of the PW Switching Point (recommended format).

This sub-TLV type contains an L2 PW address of PW Switching Point in the format described in Section 3.2 of [RFC5003]. This includes the AII type field and length, as well as the L2 PW address with the AC ID field set to zero.

7.4.2. Adaptation of Interface Parameters

[RFC4447] defines several interface parameters, which are used by the Network Service Processing (NSP) to adapt the PW to the attachment circuit (AC). The interface parameters are only used at the endpoints, and MUST be passed unchanged across the S-PE. However, the following interface parameters MAY be modified as follows:

- 0x03 Optional Interface Description string
This Interface parameter MAY be modified or altogether removed from the FEC element depending on local configuration policies.
- 0x09 Fragmentation indicator
This parameter MAY be inserted in the FEC by the switching point if it is capable of re-assembly of fragmented PW frames according to [RFC4623].

- 0x0C VCCV parameter

This Parameter contains the Control Channel (CC) type and Connectivity Verification (CV) type bit fields. The CV type bit field MUST be reset to reflect the CV type supported by the S-PE. The CC type bit field MUST have bit 1 "Type 2: MPLS Router Alert Label" set to 0. The other bit fields MUST be reset to reflect the CC type supported by the S-PE.

7.5. Group ID

The Group ID (GR ID) is used to reduce the number of status messages that need to be sent by the PE advertising the PW FEC. The GR ID has local significance only, and therefore MUST be mapped to a unique GR ID allocated by the S-PE.

7.6. PW Loop Detection

A switching point PE SHOULD inspect the PW Switching Point PE TLV, to verify that its own IP address does not appear in it. If the PE's IP address appears in a received PW Switching Point PE TLV, the PE SHOULD break the loop and send a label release message with the following error code:

Value	E	Description
0x0000003A	0	PW Loop Detected

If an S-PE along the MS-PW removed all SP-PE TLVs, as mentioned above, this loop detection method will fail.

8. MPLS-PW to L2TPv3-PW Control Plane Switching

Both MPLS and L2TPv3 PWs may be static or dynamic. This results in four possibilities when switching between L2TPv3 and MPLS.

- i. Switching between static MPLS and L2TPv3 PWs
- ii. Switching between a static MPLS PW and a dynamic L2TPv3 PW
- iii. Switching between a static L2TPv3 PW and a dynamic LDP/MPLS PW
- iv. Switching between a dynamic LDP/MPLS PW and a dynamic L2TPv3 PW

8.1. Static MPLS and L2TPv3 PWs

In the case of two static control planes, the S-PE MUST be configured to direct packets from one PW into the other. There is no control protocol involved in this case. The configuration MUST include which MPLS PW Label maps to which L2TPv3 Session ID (and associated Cookie, if present) as well as which MPLS Tunnel Label maps to which PE destination IP address.

8.2. Static MPLS PW and Dynamic L2TPv3 PW

When a statically configured MPLS PW is switched to a dynamic L2TPv3 PW, the static control plane should be considered identical to an attachment circuit (AC) in the reference model of Figure 1. The switching point PE SHOULD signal the appropriate PW status if it detects a failure in sending or receiving packets over the static PW. Because the PW is statically configured, the status communicated to the dynamic L2TPv3 PW will be limited to local interface failures. In this case, the S-PE behaves in a very similar manner to a T-PE, assuming an active role.

8.3. Static L2TPv3 PW and Dynamic LDP/MPLS PW

When a statically configured L2TPv3 PW is switched to a dynamic LDP/MPLS PW, then the static control plane should be considered identical to an attachment circuit (AC) in the reference model of Figure 1. The switching point PE SHOULD signal the appropriate PW status (via an L2TPv3 Set-Link-Info (SLI) message) if it detects a failure in sending or receiving packets over the static PW. Because the PW is statically configured, the status communicated to the dynamic LDP/MPLS PW will be limited to local interface failures. In this case, the S-PE behaves in a very similar manner to a T-PE, assuming an active role.

8.4. Dynamic LDP/MPLS and L2TPv3 PWs

When switching between dynamic PWs, the switching point always assumes an initial passive role. Thus, it does not initiate an LDP/MPLS or L2TPv3 PW until it has received a connection request (Label Mapping or Incoming-Call-Request (ICRQ)) from one side of the node. Note that while MPLS PWs are made up of two unidirectional Label Switched Paths (LSPs) bonded together by FEC identifiers, L2TPv3 PWs are bidirectional in nature, setup via a three-message exchange (ICRQ, Incoming-Call-Reply (ICRP), and Incoming-Call-Connected (ICCN)). Details of Session Establishment, Tear Down, and PW Status signaling are detailed below.

8.4.1. Session Establishment

When the S-PE receives an L2TPv3 ICRQ message, the identifying AVPs included in the message are mapped to FEC identifiers and sent in an LDP Label Mapping message. Conversely, if an LDP Label Mapping message is received, it is either mapped to an ICRP message or causes an L2TPv3 session to be initiated by sending an ICRQ.

Following are two example exchanges of messages between LDP and L2TPv3. The first is a case where an L2TPv3 T-PE initiates an MS-PW; the second is a case where an MPLS T-PE initiates an MS-PW.

```

PE 1 (L2TPv3)      PW Switching Node      PE3 (MPLS/LDP)

  AC "Up"
  L2TPv3 ICRQ ---->
                    LDP Label Mapping ---->
                                AC "Up"
                                <--- LDP Label Mapping
                    <--- L2TPv3 ICRP
  L2TPv3 ICCN ---->
<----- MS-PW Established ----->
PE 1 (MPLS/LDP)    PW Switching Node      PE3 (L2TPv3)

  AC "Up"
  LDP Label Mapping ---->
                    L2TPv3 ICRQ ---->
                                <--- L2TPv3 ICRP
                    <--- LDP Label Mapping
                    L2TPv3 ICCN ---->
                                AC "Up"
<----- MS-PW Established ----->

```

8.4.2. Adaptation of PW Status Message

L2TPv3 uses the SLI message to indicate an interface status change (such as the interface transitioning from "Up" or "Down"). MPLS/LDP PWs either signal this via an LDP Label Withdraw or the PW Status Notification message defined in Section 4.4 of [RFC4447]. The LDP status TLV bit SHOULD be mapped to the L2TPv3 equivalent Extended Circuit Status Values TLV specified in [RFC5641].

8.4.3. Session Tear Down

L2TPv3 uses a single message, Call-Disconnect-Notify (CDN), to tear down a pseudowire. The CDN message translates to a Label Withdraw message in LDP. Following are two example exchanges of messages

between LDP and L2TPv3. The first is a case where an L2TPv3 T-PE initiates the termination of an MS-PW; the second is a case where an MPLS T-PE initiates the termination of an MS-PW.

```
PE 1 (L2TPv3)      PW Switching Node      PE3 (MPLS/LDP)
```

```
AC "Down"
  L2TPv3 CDN ---->
                LDP Label Withdraw ---->
                                                AC "Down"
                                                <-- LDP Label Release
```

```
<----- MS-PW Data Path Down ----->
```

```
PE 1 (MPLS LDP)    PW Switching Node      PE3 (L2TPv3)
```

```
AC "Down"
LDP Label Withdraw ---->
                L2TPv3 CDN -->
                <-- LDP Label Release
                                                AC "Down"
```

```
<----- MS-PW Data Path Down ----->
```

8.5. Adaptation of L2TPv3 AVPs to Interface Parameters

[RFC4447] defines several interface parameters that MUST be mapped to the equivalent AVPs in L2TPv3 setup messages.

* Interface MTU

The Interface MTU parameter is mapped directly to the L2TP "Interface Maximum Transmission Unit" AVP defined in [RFC4667].

* Max Number of Concatenated ATM cells

This interface parameter is mapped directly to the L2TP "ATM Maximum Concatenated Cells AVP" described in Section 6 of [RFC4454].

* PW Type

The PW Type defined in [RFC4446] is mapped to the L2TPv3 "Pseudowire Type" AVP defined in [RFC3931].

* Pwid (FEC 128)

For FEC 128, the Pwid is mapped directly to the L2TPv3 "Remote End ID" AVP defined in [RFC3931].

* Generalized FEC 129 SAI/TAI

Section 4.3 of [RFC4667] defines how to encode the SAI and TAI parameters. These can be mapped directly.

Other interface parameter mappings are unsupported when switching between LDP/MPLS and L2TPv3 PWs.

8.6. PW Switching Point PE TLV in L2TPv3

When translating between LDP and L2TPv3 control messages, the PW Switching Point PE TLV described earlier in this document is carried in a single variable-length L2TP AVP present in the ICRQ and ICRP messages, and optionally in the ICCN message.

The L2TP "PW Switching Point AVP" is Attribute Type 101. The AVP MAY be hidden (the L2TP AVP H-bit may be 0 or 1), the length of the AVP is 6 plus the length of the series of Switching Point PE sub-TLVs included in the AVP, and the AVP MUST NOT be marked Mandatory (the L2TP AVP M-bit MUST be 0).

8.7. L2TPv3 and MPLS PW Data Plane

When switching between an MPLS and L2TP PW, packets are sent in their entirety from one PW to the other, replacing the MPLS label stack with the L2TPv3 and IP header or vice versa.

Section 5.4 of [RFC3985] discusses the purpose of the various shim headers necessary for enabling a pseudowire over an IP or MPLS PSN. For L2TPv3, the Payload Convergence and Sequencing function is carried out via the Default L2-Specific Sublayer defined in [RFC3931]. For MPLS, these two functions (together with PSN Convergence) are carried out via the MPLS Control Word. Since these functions are different between MPLS and L2TPv3, interworking between the two may be necessary.

The L2TP L2-Specific Sublayer and MPLS Control Word are shim headers, which in some cases are not necessary to be present at all. For example, an Ethernet PW with sequencing disabled will generally not require an MPLS Control Word or L2TP Default L2-Specific Sublayer to be present at all. In this case, Ethernet frames are simply sent from one PW to the other without any modification beyond the MPLS and L2TP/IP encapsulation and decapsulation.

The following section offers guidelines for how to interwork between L2TP and MPLS for those cases where the Payload Convergence, Sequencing, or PSN Convergence functions are necessary on one or both sides of the switching node.

8.7.1. Mapping the MPLS Control Word to L2TP

The MPLS Control Word consists of (from left to right):

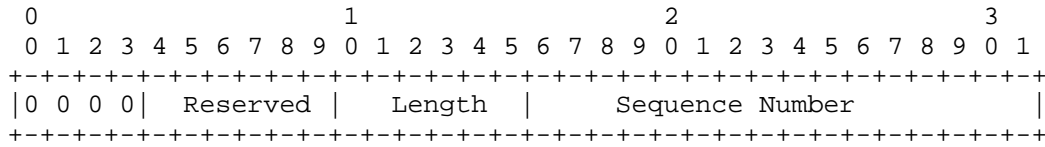

- i. These bits are always zero in an MPLS PW PDU. It is not necessary to map them to L2TP.
- ii. These six bits may be used for Payload Convergence depending on the PW type. For ATM, the first four of these bits are defined in [RFC4717]. These map directly to the bits defined in [RFC4454]. For Frame Relay, these bits indicate how to set the bits in the Frame Relay header that must be regenerated for L2TP as it carries the Frame Relay header intact.
- iii. L2TP determines its payload length from IP. Thus, this Length field need not be carried directly to L2TP. This Length field will have to be calculated and inserted for MPLS when necessary.
- iv. The Default L2-Specific Sublayer has a sequence number with different semantics than that of the MPLS Control Word. This difference eliminates the possibility of supporting sequencing across the MS-PW by simply carrying the sequence number through the switching point transparently. As such, sequence numbers MAY be supported by checking the sequence numbers of packets arriving at the switching point and regenerating a new sequence number in the appropriate format for the PW on egress. If this type of sequence interworking at the switching node is not supported, and a T-PE requests sequencing of all packets via the L2TP control channel during session setup, the switching node SHOULD NOT allow the session to be established by sending a CDN message with Result Code set to 31 "Sequencing not supported".

9. Operations, Administration, and Maintenance (OAM)

9.1. Extensions to VCCV to Support MS-PWs

Single-segment pseudowires are signaled using the Virtual Circuit Connectivity Verification (VCCV) parameter included in the interface parameter field of the PwID FEC TLV or the interface parameter sub-TLV of the Generalized PwID FEC TLV as described in [RFC5085]. When a switching point exists between PE nodes, it is required to be able to continue operating VCCV end-to-end across a switching point and to provide the ability to trace the path of the MS-PW over any number of segments.

This document provides a method for achieving these two objectives. This method is based on reusing the existing VCCV Control Word (CW) and decrementing the TTL of the PW label at each S-PE in the path of the MS-PW.

9.2. OAM from MPLS PW to L2TPv3 PW

When an MS-PW includes SS-PWs that use the L2TPv3, the MPLS PW OAM MUST be terminated at the S-PE connecting the L2TPv3 and MPLS segments. Status information received in a particular PW segment can then be used to generate the appropriate status messages on the following PW segment. In the case of L2TPv3, the status bits in the circuit status AVP defined in Section 5.4.5 of [RFC3931] and Extended Circuit Status Values defined in [RFC5641] can be mapped directly to the PW status bits defined in Section 5.4.3 of [RFC4447].

VCCV messages are specific to the MPLS data plane and cannot be used for an L2TPv3 PW segment. Therefore, the S-PE MUST NOT send the VCCV parameter included in the interface parameter field of the PwID FEC TLV or the sub-TLV interface parameter of the Generalized PwID FEC TLV. It might be possible to translate VCCV messages from L2TPv3 PW segments to MPLS PW segments and vice versa; however, this topic is left for further study.

9.3. OAM Data Plane Indication from MPLS PW to MPLS PW

As stated above, the S-PE MUST perform a standard MPLS label swap operation on the MPLS PW label. By the rules defined in [RFC3032], the PW label TTL MUST be decreased at every S-PE. Once the PW label TTL reaches the value of 0, the packet is sent to the control plane to be processed. Hence, by controlling the PW TTL value of the PW label, it is possible to select exactly which S-PE will respond to the VCCV packet.

9.4. Signaling OAM Capabilities for Switched Pseudowires

Similarly to SS-PW, MS-PW VCCV capabilities are signaled using the VCCV parameter included in the interface parameter field of the Pwid FEC TLV or the sub-TLV interface parameter of the Generalized Pwid FEC TLV as described in [RFC5085].

In Figure 3, T-PE1 uses the VCCV parameter included in the interface parameter field of the Pwid FEC TLV or the sub-TLV interface parameter of the Generalized Pwid FEC TLV to indicate to the far-end T-PE2 what VCCV capabilities T-PE1 supports. This is the same VCCV parameter as would be used if T-PE1 and T-PE2 were connected directly. S-PE2, which is a PW switching point, as part of the adaptation function for interface parameters, processes locally the VCCV parameter then passes it to T-PE2. If there were multiple S-PEs on the path between T-PE1 and T-PE2, each would carry out the same processing, passing along the VCCV parameter. The local processing of the VCCV parameter removes CC Types specified by the originating T-PE that are not supported on the S-PE. For example, if T-PE1 indicates that it supports CC Types 1, 2, and 3, then the S-PE removes the Router Alert CC Type 2, leaving the rest of the TLV unchanged, and passes the modified VCCV parameter to the next S-PE along the path.

The far end T-PE (T-PE2) receives the VCCV parameter indicating only the CC Types that are supported by the initial T-PE (T-PE1) and all S-PEs along the PW path.

9.5. OAM Capability for MS-PWs Demultiplexed Using MPLS

The VCCV parameter ID is defined as follows in [RFC4446]:

Parameter ID	Length	Description
0x0c	4	VCCV

The format of the VCCV parameter field is as follows:

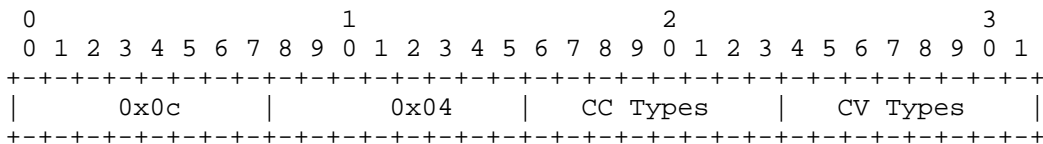

- Bit 0 (0x01) - Type 1: PWE3 Control Word with 0001b as first nibble as defined in [RFC4385]
- Bit 1 (0x02) - Type 2: MPLS Router Alert Label
- Bit 2 (0x04) - Type 3: MPLS Demultiplexor PW Label with TTL == 1 (Type 3).

9.5.1. MS-PW and VCCV CC Type 1

VCCV CC Type 1 can be used for MS-PWs. However, if the CW is enabled on user packets, VCCV CC Type 1 MUST be used according to the rules in [RFC5085]. When using CC Type 1 for MS-PWs, the PE transmitting the VCCV packet MUST set the TTL to the appropriate value to reach the destination S-PE. However, if the packet is destined for the T-PE, the TTL can be set to any value that is sufficient for the packet to reach the T-PE.

9.5.2. MS-PW and VCCV CC Type 2

VCCV CC Type 2 is not supported for MS-PWs and MUST be removed from a VCCV parameter field by the S-PE.

9.5.3. MS-PW and VCCV CC Type 3

VCCV CC Type 3 can be used for MS-PWs; however, if the CW is enabled, VCCV Type 1 is preferred according to the rules in [RFC5085]. Note that for using the VCCV Type 3, TTL method, the PE will set the PW label TTL to the appropriate value necessary to reach the target PE; otherwise, the VCCV packet might be forwarded over the AC to the Customer Premise Equipment (CPE).

9.6. MS-PW VCCV Operations

This document specifies four VCCV operations:

- i. End-to-end MS-PW connectivity verification. This operation enables the connectivity of the MS-PW to be tested from source T-PE to destination T-PE. In order to do this, the sending T-PE must include the FEC used in the last segment of the MS-PW to the destination T-PE in the VCCV-Ping echo request. This information is either configured at the sending T-PE or is obtained by processing the corresponding sub-TLVs of the optional SP-PE TLV, as described below.
- ii. Partial MS-PW connectivity verification. This operation enables the connectivity of any contiguous subset of the segments of an MS-PW to be tested from the source T-PE or a source S-PE to a destination S-PE or T-PE. Again, the FEC used on the last segment to be tested must be included in the VCCV-Ping echo request message. This information is determined by the sending T-PE or S-PE as in (i) above.
- iii. MS-PW path verification. This operation verifies the path of the MS-PW, as returned by the SP-PE TLV, against the actual data path of the MS-PW. The sending T-PE or S-PE

iteratively sends a VCCV echo request to each S-PE along the MS-PW path, using the FEC for the corresponding MS-PW segment in the SP-PE TLV. If the SP-PE TLV information is correct, then a VCCV echo reply showing that this is a valid router for the FEC will be received. However, if the SP-PE TLV information is incorrect, then this operation enables the first incorrect switching point to be determined, but not the actual path of the MS-PW beyond that. This operation cannot be used when the MS-PW is statically configured or when the SP-PE TLV is not supported. The processing of the PW Switching Point PE TLV used for this operation is described below. This operation is OPTIONAL.

- iv. MS-PW path trace. This operation traces the data path of the MS-PW using FECs included in the Target FEC stack TLV [RFC4379] returned by S-PEs or T-PEs in an echo reply message. The sending T-PE or S-PE uses this information to recursively test each S-PE along the path of the MS-PW in a single operation in a similar manner to LSP trace. This operation is able to determine the actual data path of the MS-PW, and can be used for both statically configured and signaled MS-PWs. Support for this operation is OPTIONAL.

Note that the above operations rely on intermediate S-PEs and/or the destination T-PE to include the PW Switching Point PE TLV as a part of the MS-PW setup process, or to include the Target FEC stack TLV in the VCCV echo reply message. For various reasons, e.g., privacy or security of the S-PE/T-PE, this information may not be available to the source T-PE. In these cases, manual configuration of the FEC MAY still be used.

9.6.1. VCCV Echo Message Processing

The challenge for the control plane is to be able to build the VCCV echo request packet with the necessary information to reach the desired S-PE or T-PE, for example, the target FEC 128 PW sub-TLV of the downstream PW segment that the packet is destined for. This could be even more difficult in situations in which the MS-PW spans different providers and Autonomous Systems.

For example, in Figure 3, T-PE1 has the FEC 128 of the segment (PW segment 1), but it does not readily have the information required to compose the FEC 128 of the following segment (PW segment 3), if a VCCV echo request is to be sent to T-PE2. This can be achieved by the methods described in the following subsections.

9.6.1.1. Sending a VCCV Echo Request

When performing a partial or end-to-end connectivity or path verification, the sender of the echo request message requires the FEC of the last segment to the target S-PE/T-PE node. This information can either be configured manually or be obtained by inspecting the corresponding sub-TLVs of the PW Switching Point PE TLV.

The necessary SP-PE sub-TLVs are:

Type	Description
0x01	PWid of last PW segment traversed
0x03	Local IP address of PW Switching Point
0x04	Remote IP address of last PW Switching Point traversed or of the T-PE

When performing an OPTIONAL MS-PW path trace operation, the T-PE will automatically learn the target FEC by probing, one by one, the S-PEs of the MS-PW path, using the FEC returned in the Target FEC stack of the previous VCCV echo reply.

9.6.1.2. Receiving a VCCV Echo Request

Upon receiving a VCCV echo request, the control plane on S-PEs (or the target node of each segment of the MS-PW) validates the request and responds to the request with an echo reply consisting of a return code of 8 (label switched at stack depth) indicating that it is an S-PE and not the egress router for the MS-PW.

S-PEs that wish to reveal their downstream next-hop in a trace operation should include the FEC of the downstream PW segment in the Target FEC stack (as per Sections 3.2 and 4.5 of [RFC4379]) of the echo reply message. FEC 128 PWs MUST use the format shown in Section 3.2.9 of [RFC4379] for the sub-TLV in the Target FEC stack, while FEC 129 PWs MUST use the format shown in Section 3.2.10 of [RFC4379] for the sub-TLV in the Target FEC stack. Note that an S-PE MUST NOT include this FEC information in the reply if it has been configured not to do so for administrative reasons or for reasons explained previously.

If the node is the T-PE or the egress node of the MS-PW, it responds to the echo request with an echo reply with a return code of 3 (Egress Router).

9.6.1.3. Receiving a VCCV Echo Reply

The operation to be taken by the node receiving the echo reply in response to an echo request depends on the VCCV mode of operation described above. See Section 9.5.2 for detailed procedures.

9.6.2. Detailed VCCV Procedures

There are two similar methods of verifying the MS-PW path: Path Trace and Path Verification. Path Trace does not use the LDP control plane to obtain information on the path to verify, so this method is well suited if portions of the MS-PW are statically configured SS-PWs. The Path Verification method relies on information obtained from the LDP control plane, and hence offers better verification of the current forwarding behavior compared to the LDP signaled forwarding information of the MS-PW path. However, in the case where there are statically signaled SS-PWs in the MS-PW path, the path information is unavailable and must be programmed manually.

9.6.2.1. End-to-End Connectivity Verification between T-PEs

In Figure 3, if T-PE1, S-PE, and T-PE2 support Control Word, the PW control plane will automatically negotiate the use of the CW. VCCV CC Type 3 will function correctly whether or not the CW is enabled on the PW. However, VCCV Type 1 (which can be use for end-to-end verification only) is only supported if the CW is enabled.

At the S-PE, the data path operations include an outer label pop, inner label swap, and new outer label push. Note that there is no requirement for the S-PE to inspect the CW. Thus, the end-to-end connectivity of the multi-segment pseudowire can be verified by performing all of the following steps:

- i. The T-PE forms a VCCV-Ping echo request message with the FEC matching that of the last PW segment to the destination T-PE.
- ii. The T-PE sets the inner PW label TTL to the exact value to allow the packet to reach the far-end T-PE. (The value is determined by counting the number of S-PEs from the control plane information.) Alternatively, if CC Type 1 is supported, the packet can be encapsulated according to CC Type 1 in [RFC5085].
- iii. The T-PE sends a VCCV packet that will follow the exact same data path at each S-PE as that taken by data packets.

- iv. The S-PE may perform an outer label pop, if Penultimate Hop Popping (PHP) is disabled, and will perform an inner label swap with TTL decrement and a new outer label push.
- v. There is no requirement for the S-PE to inspect the CW.
- vi. The VCCV packet is diverted to VCCV control processing at the destination T-PE.
- vii. The destination T-PE replies using the specified reply mode, i.e., reverse PW path or IP path.

9.6.2.2. Partial Connectivity Verification from T-PE

In order to trace part of the multi-segment pseudowire, the TTL of the PW label may be used to force the VCCV message to 'pop out' at an intermediate node. When the TTL expires, the S-PE can determine that the packet is a VCCV packet either by checking the CW or (if the CW is not in use) by checking for a valid IP header with UDP destination port 3503. The packet should then be diverted to VCCV processing.

In Figure 3, if T-PE1 sends a VCCV message with the TTL of the PW label equal to 1, the TTL will expire at the S-PE. T-PE1 can thus verify the first segment of the pseudowire.

The VCCV packet is built according to [RFC4379], Section 3.2.9 for FEC 128, or Section 3.2.10 for FEC 129. All the information necessary to build the VCCV LSP ping packet is collected by inspecting the S-PE TLVs.

Note that this use of the TTL is subject to the caution expressed in [RFC5085]. If a penultimate LSR between S-PEs or between an S-PE and a T-PE manipulates the PW label TTL, the VCCV message may not emerge from the MS-PW at the correct S-PE.

9.6.2.3. Partial Connectivity Verification between S-PEs

Assuming that all nodes along an MS-PW support the Control Word CC Type 3, VCCV between S-PEs may be accomplished using the PW label TTL as described above. In Figure 3, the S-PE may verify the path between it and T-PE2 by sending a VCCV message with the PW label TTL set to 1. Given a more complex network with multiple S-PEs, an S-PE may verify the connectivity between it and an S-PE two segments away by sending a VCCV message with the PW label TTL set to 2. Thus, an S-PE can diagnose connectivity problems by successively increasing the TTL. All the information needed to build the proper VCCV echo

request packet (as described in [RFC4379], Sections 3.2.9 or 3.2.10) is obtained automatically from the LDP label mapping that contains S-PE TLVs.

9.6.2.4. MS-PW Path Verification

As an example, in Figure 3, VCCV trace can be performed on the MS-PW originating from T-PE1 by a single operational command. The following process ensues:

- i. T-PE1 sends a VCCV echo request with TTL set to 1 and a FEC containing the pseudowire information of the first segment (PW1 between T-PE1 and S-PE) to S-PE for validation. If FEC Stack Validation is enabled, the request may also include an additional sub-TLV such as LDP Prefix and/or RSVP LSP, dependent on the type of transport tunnel the segmented PW is riding on.
- ii. S-PE validates the echo request with the FEC. Since it is a switching point between the first and second segment, it builds an echo reply with a return code of 8 and sends the echo reply back to T-PE1.
- iii. T-PE1 builds a second VCCV echo request based on the information obtained from the control plane (SP-PE TLV). It then increments the TTL and sends it out to T-PE2. Note that the VCCV echo request packet is switched at the S-PE data path and forwarded to the next downstream segment without any involvement from the control plane.
- iv. T-PE2 receives and validates the echo request with the FEC. Since T-PE2 is the destination node or the egress node of the MS-PW, it replies to T-PE1 with an echo reply with a return code of 3 (Egress Router).
- v. T-PE1 receives the echo reply from T-PE2. T-PE1 is made aware that T-PE2 is the destination of the MS-PW because the echo reply has a return code of 3. The trace process is completed.

If no echo reply is received, or an error code is received from a particular PE, the trace process MUST stop immediately, and packets MUST NOT be sent further along the MS-PW.

For more detail on the format of the VCCV echo packet, refer to [RFC5085] and [RFC4379]. The TTL here refers to that of the inner (PW) label TTL.

9.6.2.5. MS-PW Path Trace

As an example, in Figure 3, VCCV trace can be performed on the MS-PW originating from T-PE1 by a single operational command. The following OPTIONAL process ensues:

- i. T-PE1 sends a VCCV echo request with TTL set to 1 and a FEC containing the pseudowire information of the first segment (PW1 between T-PE1 and S-PE) to S-PE for validation. If FEC Stack Validation is enabled, the request may also include an additional sub-TLV such as LDP Prefix and/or RSVP LSP, dependent on the type of transport tunnel the segmented PW is riding on.
- ii. The S-PE validates the echo request with the FEC.
- iii. The S-PE builds an echo reply with a return code of 8 and sends the echo reply back to T-PE1, appending the FEC 128 information for the next segment along the MS-PW to the VCCV echo reply packet using the Target FEC stack TLV (as per Sections 3.2 and 4.5 of [RFC4379]).
- iv. T-PE1 builds a second VCCV echo request based on the information obtained from the FEC stack TLV received in the previous VCCV echo reply. It then increments the TTL and sends it out to T-PE2. Note that the VCCV echo request packet is switched at the S-PE data path and forwarded to the next downstream segment without any involvement from the control plane.
- v. T-PE2 receives and validates the echo request with the FEC. Since T-PE2 is the destination node or the egress node of the MS-PW, it replies to T-PE1 with an echo reply with a return code of 3 (Egress Router).
- vi. T-PE1 receives the echo reply from T-PE2. T-PE1 is made aware that T-PE2 is the destination of the MS-PW because the echo reply has a return code of 3. The trace process is completed.

If no echo reply is received, or an error code is received from a particular PE, the trace process MUST stop immediately, and packets MUST NOT be sent further along the MS-PW.

For more detail on the format of the VCCV echo packet, refer to [RFC5085] and [RFC4379]. The TTL here refers to that of the inner (PW) label TTL.

10. Mapping Switched Pseudowire Status

In the PW switching with attachment circuits case (Figure 2), PW status messages indicating PW or attachment circuit faults MUST be mapped to fault indications or OAM messages on the connecting AC as defined in [PW-MSG-MAP].

In the PW control plane switching case (Figure 3), there is no attachment circuit at the S-PE, but the two PWs are connected together. Similarly, the status of the PWs is forwarded unchanged from one PW to the other by the control plane switching function. However, it may sometimes be necessary to communicate fault status of one of the locally attached PW segments at an S-PE. For LDP, this can be accomplished by sending an LDP notification message containing the PW status TLV, as well as an OPTIONAL PW Switching Point PE TLV as follows:

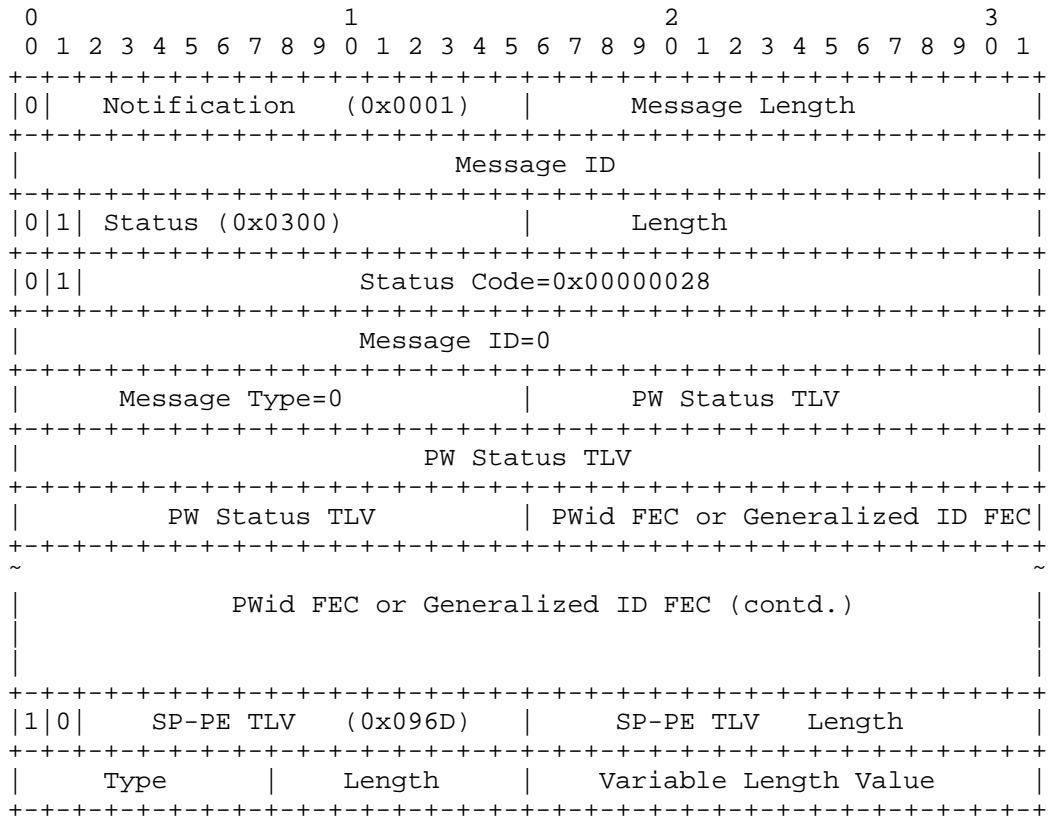

Only one SP-PE TLV can be present in this message. This message is then relayed by each S-PE unchanged. The T-PE decodes the status message and the included SP-PE TLV to detect exactly where the fault occurred. At the T-PE, if there is no SP-PE TLV included in the LDP status notification, then the status message can be assumed to have originated at the remote T-PE.

The merging of the received LDP status and the local status for the PW segments at an S-PE can be summarized as follows:

- i. When the local status for both PW segments is UP, the S-PE passes any received AC or PW status bits unchanged, i.e., the status notification TLV is unchanged, but the PWid in the case of a FEC 128 TLV is set to the value of the PW segment of the next hop.
- ii. When the local status for any of the PW segments is at fault, the S-PE always sends the local status bits regardless of whether the received status bits from the remote node indicated that an upstream fault has cleared. AC status bits are passed along unchanged.

10.1. PW Status Messages Initiated by the S-PE

The PW fault directions are defined as follows:

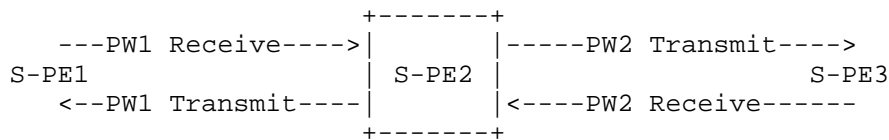

Figure 4: S-PE and PW Transmission/Reception Directions

When a local fault is detected by the S-PE, a PW status message is sent in both directions along the PW. Since there are no attachment circuits on an S-PE, only the following status messages are relevant:

```

0x00000008 - Local PSN-facing PW (ingress) Receive Fault
0x00000010 - Local PSN-facing PW (egress) Transmit Fault

```

Each S-PE needs to store only two 32-bit PW status words for each PW segment: one for local failures and one for remote failures (normally received from another PE). The first failure will set the appropriate bit in the 32-bit status word, and each subsequent failure will be ORed to the appropriate PW status word. In the case

that the PW status word stores remote failures, this rule has the effect of a logical OR operation with the first failure received on the particular PW segment.

It should be noted that remote failures received on an S-PE are just passed along the MS-PW unchanged, while local failures detected on an S-PE are signaled on both PW segments.

A T-PE can receive multiple failures from S-PEs along the MS-PW; however, only the failure from the remote closest S-PE will be stored (last PW status message received). The PW status word received is just ORed to any existing remote PW status already stored on the T-PE.

Given that there are two PW segments at a particular S-PE for a particular MS-PW (referring to Figure 4), there are four possible failure cases as follows:

- i. PW2 Transmit direction fault
- ii. PW1 Transmit direction fault
- iii. PW2 Receive direction fault
- iv. PW1 Receive direction fault

Once a PW status notification message is initiated at an S-PE for a particular PW status bit, any further status message for the same status bit (and received from an upstream neighbor) is processed locally and not forwarded until the S-PE original status error state is cleared.

Each S-PE along the MS-PW MUST store any PW status messages transiting it. If more than one status message with the same PW status bit set is received by a T-PE or S-PE, only the last PW status message is stored.

10.1.1.1. Local PW2 Transmit Direction Fault

When this failure occurs, the S-PE will take the following actions:

- * Send a PW status message to S-PE3 containing "0x00000010 - Local PSN-facing PW (egress) Transmit Fault".
- * Send a PW status message to S-PE1 containing "0x00000008 - Local PSN-facing PW (ingress) Receive Fault".
- * Store 0x00000010 in the local PW status word for the PW segment toward S-PE3.

10.1.2. Local PW1 Transmit Direction Fault

When this failure occurs, the S-PE will take the following actions:

- * Send a PW status message to S-PE1 containing "0x00000010 - Local PSN-facing PW (egress) Transmit Fault".
- * Send a PW status message to S-PE3 containing "0x00000008 - Local PSN-facing PW (ingress) Receive Fault".
- * Store 0x00000010 in the local PW status word for the PW segment toward S-PE1.

10.1.3. Local PW2 Receive Direction Fault

When this failure occurs, the S-PE will take the following actions:

- * Send a PW status message to S-PE3 containing "0x00000008 - Local PSN-facing PW (ingress) Receive Fault".
- * Send a PW status message to S-PE1 containing "0x00000010 - Local PSN-facing PW (egress) Transmit Fault".
- * Store 0x00000008 in the local PW status word for the PW segment toward S-PE3.

10.1.4. Local PW1 Receive Direction Fault

When this failure occurs, the S-PE will take the following actions:

- * Send a PW status message to S-PE1 containing "0x00000008 - Local PSN-facing PW (ingress) Receive Fault".
- * Send a PW status message to S-PE3 containing "0x00000010 - Local PSN-facing PW (egress) Transmit Fault".
- * Store 0x00000008 in the local PW status word for the PW segment toward S-PE1.

10.1.5. Clearing Faults

Remote PW status fault clearing messages received by an S-PE will only be forwarded if there are no corresponding local faults on the S-PE. (Local faults always supersede remote faults.)

Once the local fault has cleared, and there is no corresponding (same PW status bit set) remote fault, a PW status message is sent out to the adjacent PEs, clearing the fault.

When a PW status fault clearing message is forwarded, the S-PE will always send the SP-PE TLV associated with the PE that cleared the fault.

10.2. PW Status Messages and SP-PE TLV Processing

When a PW status message is received that includes an SP-PE TLV, the SP-PE TLV information MAY be stored, along with the contents of the PW status Word according to the procedures described above. The SP-PE TLV stored is always the SP-PE TLV that is associated with the PE that set that particular last fault. If subsequent PW status messages for the same PW status bit are received, the SP-PE TLV will overwrite the previously stored SP-PE TLV.

10.3. T-PE Processing of PW Status Messages

The PW switching architecture is based on the concept that the T-PE should process the PW LDP messages in the same manner as if it were participating in the setup of a PW segment. However, a T-PE participating in an MS-PW SHOULD be able to process the SP-PE TLV. Otherwise, the processing of PW status messages and other PW setup messages is exactly as described in [RFC4447].

10.4. Pseudowire Status Negotiation Procedures

Pseudowire status signaling methodology, defined in [RFC4447], SHOULD be transparent to the switching point.

10.5. Status Dampening

When the PW control plane switching methodology is used to cross an administrative boundary, it might be necessary to prevent excessive status signaling changes from being propagated across the administrative boundary. This can be achieved by using a similar method as commonly employed for the BGP route advertisement dampening. The details of this OPTIONAL algorithm are a matter of implementation and are outside the scope of this document.

11. Peering between Autonomous Systems

The procedures outlined in this document can be employed to provision and manage MS-PWs crossing AS boundaries. The use of more advanced mechanisms involving auto-discovery and ordered PWE3 MS-PW signaling will be covered in a separate document.

12. Congestion Considerations

Each PSN carrying the PW may be subject to congestion. The congestion considerations in [RFC3985] apply to PW segments as well. Each PW segment will handle any congestion experienced by the PW traffic independently of the other MS-PW segments. It is possible that passing knowledge of congestion between segments and to the T-PEs can result in more efficient edge-to-edge congestion mitigation systems. However, any specific methods of congestion mitigation are outside the scope of this document and left for further study.

13. Security Considerations

This document specifies the LDP, L2TPv3, and VCCV extensions that are needed for setting up and maintaining pseudowires. The purpose of setting up pseudowires is to enable Layer 2 frames to be encapsulated and transmitted from one end of a pseudowire to the other. Therefore, we discuss the security considerations for both the data plane and the control plane in the following sections. The guidelines and security considerations specified in [RFC5920] also apply to MS-PW when the PSN is MPLS.

13.1. Data Plane Security

Data plane security considerations as discussed in [RFC4447], [RFC3931], and [RFC3985] apply to this extension without any changes.

13.1.1. VCCV Security Considerations

The VCCV technology for MS-PW offers a method for the service provider to verify the data path of a specific PW. This involves sending a packet to a specific PE and receiving an answer that either confirms the information contained in the packet or indicates that it is incorrect. This is a very similar process to the commonly used IP ICMP ping and TTL expired methods for IP networks. It should be noted that when using VCCV Type 3 for PW when the CW is not enabled, if a packet is crafted with a TTL greater than the number of hops along the MS-PW path, or an S-PE along the path mis-processes the TTL, the packet could mistakenly be forwarded out of the attachment circuit as a native PW packet. This packet would most likely be treated as an error packet by the CE. However, if this possibility is not acceptable, the CW should be enabled to guarantee that a VCCV packet will never be mistakenly forwarded to the AC.

13.2. Control Protocol Security

General security considerations with regard to the use of LDP are specified in Section 5 of RFC 5036. Security considerations with regard to the L2TPv3 control plane are specified in [RFC3931]. These considerations apply as well to the case where LDP or L2TPv3 is used to set up PWs.

A pseudowire connects two attachment circuits. It is important to make sure that LDP connections are not arbitrarily accepted from anywhere, or else a local attachment circuit might get connected to an arbitrary remote attachment circuit. Therefore, an incoming session request **MUST NOT** be accepted unless its IP source address is known to be the source of an "eligible" peer. The set of eligible peers could be pre-configured (either as a list of IP addresses or as a list of address/mask combinations), or it could be discovered dynamically via an auto-discovery protocol that is itself trusted. (Note that if the auto-discovery protocol were not trusted, the set of "eligible peers" it produces could not be trusted.)

Even if a connection request appears to come from an eligible peer, its source address may have been spoofed. So some means of preventing source address spoofing must be in place. For example, if all the eligible peers are in the same network, source address filtering at the border routers of that network could eliminate the possibility of source address spoofing.

For a greater degree of security, the LDP authentication option, as described in Section 2.9 of [RFC5036], or the Control Message Authentication option of [RFC3931], **MAY** be used. This provides integrity and authentication for the control messages, and eliminates the possibility of source address spoofing. Use of the message authentication option does not provide privacy, but privacy of control messages is not usually considered to be highly important. Both the LDP and L2TPv3 message authentication options rely on the configuration of pre-shared keys, making it difficult to deploy when the set of eligible neighbors is determined by an auto-configuration protocol.

The protocol described in this document relies on the LDP MD5 authentication key option, as described in Section 2.9 of [RFC5036], to provide integrity and authentication for the LDP messages and protect against source address spoofing. This mechanism relies on the configuration of pre-shared keys, which typically introduces some fragility. In the specific case of MS-PW, the number of links that leave an organization will be limited in practice, so the reliance on pre-shared keys should be manageable.

When the Generalized PWid FEC Element is used, it is possible that a particular peer may be one of the eligible peers, but may not be the right one to connect to the particular attachment circuit identified by the particular instance of the Generalized ID FEC element. However, given that the peer is known to be one of the eligible peers (as discussed above), this would be the result of a configuration error, rather than a security problem. Nevertheless, it may be advisable for a PE to associate each of its local attachment circuits with a set of eligible peers, rather than have just a single set of eligible peers associated with the PE as a whole.

14. IANA Considerations

14.1. L2TPv3 AVP

This document uses a new L2TP parameter; IANA already maintains the registry "Control Message Attribute Value Pairs" defined by [RFC3438]. The following new value has been assigned:

101 PW Switching Point AVP

14.2. LDP TLV TYPE

This document uses a new LDP TLV type; IANA already maintains the registry "TLV TYPE NAME SPACE" defined by RFC 5036. The following value has been assigned:

TLV type	Description
0x096D	Pseudowire Switching Point PE TLV

14.3. LDP Status Codes

This document uses a new LDP status code; IANA already maintains the registry "STATUS CODE NAME SPACE" defined by RFC 5036. The following value has been assigned:

Assignment	E	Description
0x0000003A	0	PW Loop Detected

14.4. L2TPv3 Result Codes

This document uses a new L2TPv3 Result Code for the CDN message, as assigned by IANA in the "Result Code AVP (Attribute Type 1) Values" registry.

Registry Name: Result Code AVP (Attribute Type 1) Values Defined
Result Code values for the CDN message are:

Assignment	Description
31	Sequencing not supported

14.5. New IANA Registries

IANA has set up a registry named "Pseudowire Switching Point PE sub-TLV Type". These are 8-bit values. Type values 1 through 6 are defined in this document. Type values 7 through 64 are to be assigned by IANA using the "Expert Review" policy defined in [RFC5226]. Type values 65 through 127, as well as 0 and 255, are to be allocated using the IETF consensus policy defined in RFC 5226. Type values 128 through 254 are reserved for vendor proprietary extensions and are to be assigned by IANA, using the "First Come First Served" policy defined in RFC 5226.

The Type Values are assigned as follows:

Type	Length	Description
0x01	4	PWid of last PW segment traversed
0x02	variable	PW Switching Point description string
0x03	4/16	Local IP address of PW Switching Point
0x04	4/16	Remote IP address of last PW Switching Point traversed or of the T-PE
0x05	variable	FEC Element of last PW segment traversed
0x06	12	L2 PW address of PW Switching Point

15. Normative References

- [RFC2119] Bradner, S., "Key words for use in RFCs to Indicate Requirement Levels", BCP 14, RFC 2119, March 1997.
- [RFC2277] Alvestrand, H., "IETF Policy on Character Sets and Languages", BCP 18, RFC 2277, January 1998.
- [RFC3931] Lau, J., Ed., Townsley, M., Ed., and I. Goyret, Ed., "Layer Two Tunneling Protocol - Version 3 (L2TPv3)", RFC 3931, March 2005.
- [RFC4364] Rosen, E. and Y. Rekhter, "BGP/MPLS IP Virtual Private Networks (VPNs)", RFC 4364, February 2006.
- [RFC4379] Kompella, K. and G. Swallow, "Detecting Multi-Protocol Label Switched (MPLS) Data Plane Failures", RFC 4379, February 2006.

- [RFC4385] Bryant, S., Swallow, G., Martini, L., and D. McPherson, "Pseudowire Emulation Edge-to-Edge (PWE3) Control Word for Use over an MPLS PSN", RFC 4385, February 2006.
- [RFC4446] Martini, L., "IANA Allocations for Pseudowire Edge to Edge Emulation (PWE3)", BCP 116, RFC 4446, April 2006.
- [RFC4447] Martini, L., Ed., Rosen, E., El-Aawar, N., Smith, T., and G. Heron, "Pseudowire Setup and Maintenance Using the Label Distribution Protocol (LDP)", RFC 4447, April 2006.
- [RFC5003] Metz, C., Martini, L., Balus, F., and J. Sugimoto, "Attachment Individual Identifier (AII) Types for Aggregation", RFC 5003, September 2007.
- [RFC5036] Andersson, L., Ed., Minei, I., Ed., and B. Thomas, Ed., "LDP Specification", RFC 5036, October 2007.
- [RFC5085] Nadeau, T., Ed., and C. Pignataro, Ed., "Pseudowire Virtual Circuit Connectivity Verification (VCCV): A Control Channel for Pseudowires", RFC 5085, December 2007.
- [RFC5226] Narten, T. and H. Alvestrand, "Guidelines for Writing an IANA Considerations Section in RFCs", BCP 26, RFC 5226, May 2008.
- [RFC5641] McGill, N. and C. Pignataro, "Layer 2 Tunneling Protocol Version 3 (L2TPv3) Extended Circuit Status Values", RFC 5641, August 2009.

16. Informative References

- [PW-MSG-MAP] Aissaoui, M., Busschbach, P., Morrow, M., Martini, L., Stein, Y(J)., Allan, D., and T. Nadeau, "Pseudowire (PW) OAM Message Mapping", Work in Progress, October 2010.
- [RFC3032] Rosen, E., Tappan, D., Fedorkow, G., Rekhter, Y., Farinacci, D., Li, T., and A. Conta, "MPLS Label Stack Encoding", RFC 3032, January 2001.
- [RFC3438] Townsley, W., "Layer Two Tunneling Protocol (L2TP) Internet Assigned Numbers Authority (IANA) Considerations Update", BCP 68, RFC 3438, December 2002.

- [RFC3985] Bryant, S., Ed., and P. Pate, Ed., "Pseudo Wire Emulation Edge-to-Edge (PWE3) Architecture", RFC 3985, March 2005.
- [RFC4023] Worster, T., Rekhter, Y., and E. Rosen, Ed., "Encapsulating MPLS in IP or Generic Routing Encapsulation (GRE)", RFC 4023, March 2005.
- [RFC4454] Singh, S., Townsley, M., and C. Pignataro, "Asynchronous Transfer Mode (ATM) over Layer 2 Tunneling Protocol Version 3 (L2TPv3)", RFC 4454, May 2006.
- [RFC4623] Malis, A. and M. Townsley, "Pseudowire Emulation Edge-to-Edge (PWE3) Fragmentation and Reassembly", RFC 4623, August 2006.
- [RFC4667] Luo, W., "Layer 2 Virtual Private Network (L2VPN) Extensions for Layer 2 Tunneling Protocol (L2TP)", RFC 4667, September 2006.
- [RFC4717] Martini, L., Jayakumar, J., Bocci, M., El-Aawar, N., Brayley, J., and G. Koleyni, "Encapsulation Methods for Transport of Asynchronous Transfer Mode (ATM) over MPLS Networks", RFC 4717, December 2006.
- [RFC5254] Bitar, N., Ed., Bocci, M., Ed., and L. Martini, Ed., "Requirements for Multi-Segment Pseudowire Emulation Edge-to-Edge (PWE3)", RFC 5254, October 2008.
- [RFC5659] Bocci, M. and S. Bryant, "An Architecture for Multi-Segment Pseudowire Emulation Edge-to-Edge", RFC 5659, October 2009.
- [RFC5920] Fang, L., Ed., "Security Framework for MPLS and GMPLS Networks", RFC 5920, July 2010.

17. Acknowledgments

The authors wish to acknowledge the contributions of Satoru Matsushima, Wei Luo, Neil McGill, Skip Booth, Neil Hart, Michael Hua, and Tiberiu Grigoriu.

18. Contributors

The following people also contributed text to this document:

Florin Balus
Alcatel-Lucent
701 East Middlefield Rd.
Mountain View, CA 94043
US
EMail: florin.balus@alcatel-lucent.com

Mike Duckett
Bellsouth
Lindbergh Center, D481
575 Morosgo Dr
Atlanta, GA 30324
US
EMail: mduckett@bellsouth.net

Authors' Addresses

Luca Martini
Cisco Systems, Inc.
9155 East Nichols Avenue, Suite 400
Englewood, CO 80112
US
EMail: lmartini@cisco.com

Chris Metz
Cisco Systems, Inc.
EMail: chmetz@cisco.com

Thomas D. Nadeau
EMail: tnadeau@lucidvision.com

Matthew Bocci
Alcatel-Lucent
Grove House, Waltham Road Rd
White Waltham, Berks SL6 3TN
UK
EMail: matthew.bocci@alcatel-lucent.co.uk

Mustapha Aissaoui
Alcatel-Lucent
600, March Road,
Kanata, ON
Canada
EMail: mustapha.aissaoui@alcatel-lucent.com

