

Internet Engineering Task Force (IETF)
Request for Comments: 7131
Category: Informational
ISSN: 2070-1721

M. Barnes
F. Audet
Skype
S. Schubert
NTT
H. van Elburg
Detecon International GmbH
C. Holmberg
Ericsson
March 2014

Session Initiation Protocol (SIP) History-Info Header Call Flow Examples

Abstract

This document describes use cases and documents call flows that require the History-Info header field to capture the Request-URIs as a Session Initiation Protocol (SIP) Request is retargeted. The use cases are described along with the corresponding call flow diagrams and messaging details.

Status of This Memo

This document is not an Internet Standards Track specification; it is published for informational purposes.

This document is a product of the Internet Engineering Task Force (IETF). It represents the consensus of the IETF community. It has received public review and has been approved for publication by the Internet Engineering Steering Group (IESG). Not all documents approved by the IESG are a candidate for any level of Internet Standard; see Section 2 of RFC 5741.

Information about the current status of this document, any errata, and how to provide feedback on it may be obtained at <http://www.rfc-editor.org/info/rfc7131>.

Copyright Notice

Copyright (c) 2014 IETF Trust and the persons identified as the document authors. All rights reserved.

This document is subject to BCP 78 and the IETF Trust's Legal Provisions Relating to IETF Documents (<http://trustee.ietf.org/license-info>) in effect on the date of publication of this document. Please review these documents carefully, as they describe your rights and restrictions with respect to this document. Code Components extracted from this document must include Simplified BSD License text as described in Section 4.e of the Trust Legal Provisions and are provided without warranty as described in the Simplified BSD License.

Table of Contents

1. Overview	2
2. Conventions and Terminology	3
3. Detailed Call Flows	3
3.1. Sequentially Forking (History-Info in Response)	3
3.2. History-Info with Privacy Header Field	11
3.3. Privacy for a Specific History-Info Entry	16
3.4. Automatic Call Distribution	20
3.5. Determining the Alias Used	27
3.6. PBX Voicemail Example	29
3.7. Consumer Voicemail Example	35
3.8. GRUU	41
3.9. Limited-Use Address	44
3.10. Service Invocation	47
3.11. Toll-Free Number	48
4. Security Considerations	51
5. Acknowledgements	51
6. Informative References	51

1. Overview

Many services that use SIP require the ability to determine why and how the call arrived at a specific application. The use cases provided in this document illustrate the use of the History-Info header [RFC7044], for example, applications and common scenarios. The optional "rc" and "mp" header field parameters defined in [RFC7044] are required for several of the use cases. Descriptions of the example use cases, call flow diagrams, and messaging details are provided.

2. Conventions and Terminology

The term "retarget" is used as defined in [RFC7044]. The terms "location service", "redirect", and "address-of-record (AOR)" are used consistent with the terminology in [RFC3261].

3. Detailed Call Flows

The scenarios in this section provide sample use cases for the History-Info header for informational purposes only. They are not intended to be normative. In many cases, only the relevant messaging details are included in the body of the call flow.

3.1. Sequentially Forking (History-Info in Response)

This scenario highlights an example where the History-Info in the response is useful to an application or user that originated the request.

Alice sends a call to Bob via sip:example.com. The proxy sip:example.com sequentially tries Bob on a SIP User Agent (UA) that has bound a contact with the sip:bob@example.com AOR, and then several alternate addresses (Office and Home) unsuccessfully before sending a response to Alice. The hi-entry containing the initial contact is the hi-entry just prior to the first hi-entry tagged with an "rc" header field parameter. In this example, the Office and Home are not the same AOR as sip:bob@example.com, but rather different AORs that have been configured as alternate addresses for Bob in the proxy. In other words, Office and Home are not bound through SIP Registration with Bob's AOR. This type of arrangement is common, for example, when a "routing" rule to a Public Switched Telephone Network (PSTN) number is manually configured in a proxy. These hi-entries are identified by the index contained in the hi-target-param "mp" header field parameter in the hi-entries.

This scenario illustrates that by providing the History-Info to Alice, the end-user, or an application at Alice could make a decision on how best to attempt finding Bob without sending multiple requests to the same destination. Upon receipt of the response containing the History-Info entries, the Request-URIs for the History-Info entries tagged with an "mp" header field parameter are extracted. Those Request-URIs can be compared to other URIs (if any) that might be attempted in order to establish the session with Bob. This results in avoiding the sending of another INVITE to Bob's home phone. Without this mechanism, Alice might well attempt to reach Bob at his office phone, which would then retarget the request to Bob's home phone. When that attempt failed, then Alice might attempt to reach Bob directly at his home phone, unknowingly for a third time.

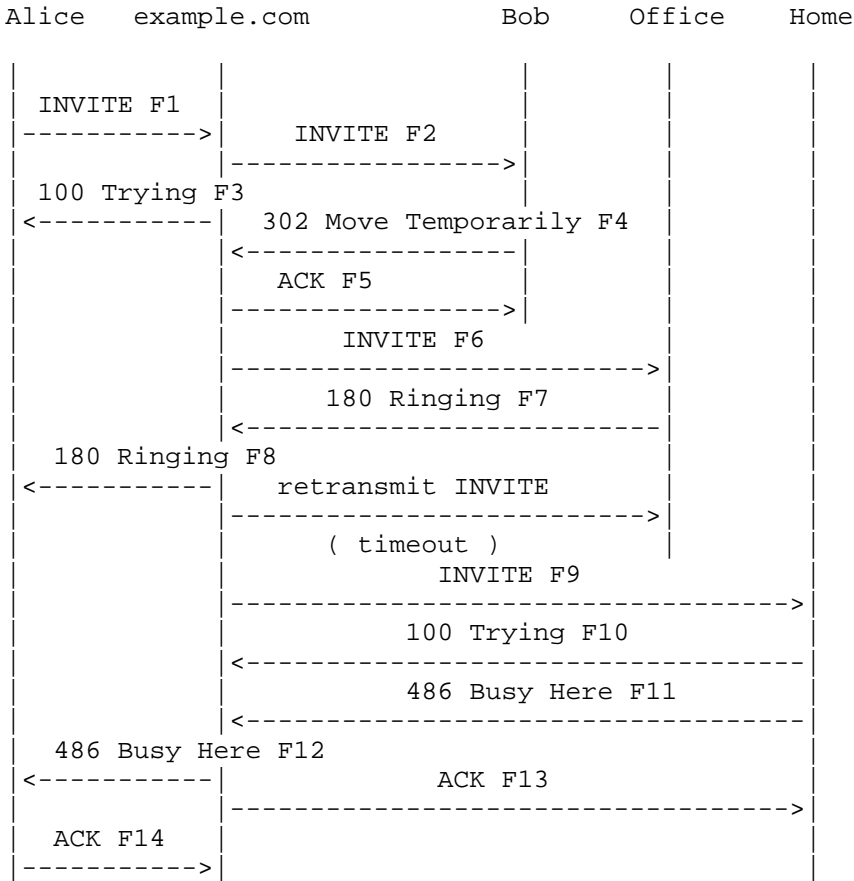

Figure 1: Example with Sequential Forking

Message Details

F1 INVITE Alice -> example.com

```
INVITE sip:bob@example.com SIP/2.0
Via: SIP/2.0/TCP 192.0.2.3:5060;branch=z9hG4bK4321
Max-Forwards: 70
From: Alice <sip:alice@example.com>;tag=sr3dds
To: Bob <sip:bob@example.com>
Supported: histinfo
Call-ID: 12345600@example.com
CSeq: 1 INVITE
History-Info: <sip:bob@example.com>;index=1
Contact: Alice <sip:alice@192.0.2.3>
Content-Type: application/sdp
Content-Length: <appropriate value>
```

[SDP Not Shown]

F2 INVITE example.com -> Bob

```
INVITE sip:bob@192.0.2.4 SIP/2.0
Via: SIP/2.0/TCP proxy.example.com:5060;branch=z9hG4bKx3st
Via: SIP/2.0/TCP 192.0.2.3:5060;branch=z9hG4bK4321
Max-Forwards: 69
From: Alice <sip:alice@example.com>;tag=sr3dds
To: Bob <sip:bob@example.com>
Supported: histinfo
Call-ID: 12345600@example.com
CSeq: 1 INVITE
Record-Route: <sip:proxy.example.com;lr>
History-Info: <sip:bob@example.com>;index=1
History-Info: <sip:bob@192.0.2.4>;index=1.1;rc=1
Contact: Alice <sip:alice@192.0.2.3>
Content-Type: application/sdp
Content-Length: <appropriate value>
```

[SDP Not Shown]

F3 100 Trying example.com -> Alice

```
SIP/2.0 100 Trying
Via: SIP/2.0/TCP 192.0.2.3:5060;branch=z9hG4bK4321
From: Alice <sip:alice@example.com>;tag=sr3dds
To: Bob <sip:bob@example.com>
Supported: histinfo
Call-ID: 12345600@example.com
CSeq: 1 INVITE
Content-Length: 0
```

F4 302 Moved Temporarily Bob -> example.com

```
SIP/2.0 302 Moved Temporarily
Via: SIP/2.0/TCP proxy.example.com:5060;branch=z9hG4bKx3st
Via: SIP/2.0/TCP 192.0.2.3:5060;branch=z9hG4bK4321
From: Alice <sip:alice@example.com>;tag=sr3dds
To: Bob <sip:bob@example.com>;tag=es43sd
Supported: histinfo
Call-ID: 12345600@example.com
CSeq: 1 INVITE
History-Info: <sip:bob@example.com>;index=1
History-Info: <sip:bob@192.0.2.4>;index=1.1;rc=1
Contact: <sip:office@example.com>;mp=1
Content-Length: 0
```

F5 ACK example.com -> Bob

```
ACK sip:bob@example.com SIP/2.0
Via: SIP/2.0/TCP proxy.example.com:5060;branch=z9hG4bKx3st
Max-Forwards: 70
From: Alice <sip:alice@example.com>;tag=sr3dds
To: Bob <sip:bob@example.com>;tag=es43sd
Call-ID: 12345600@example.com
CSeq: 1 ACK
Content-Length: 0
```

F6 INVITE example.com -> office

```
INVITE sip:office@192.0.2.5 SIP/2.0
Via: SIP/2.0/TCP proxy.example.com:5060;branch=z9hG4bKx4st
Via: SIP/2.0/TCP 192.0.2.3:5060;branch=z9hG4bK4321
Max-Forwards: 69
From: Alice <sip:alice@example.com>;tag=sr3dds
To: Bob <sip:bob@example.com>
Supported: histinfo
Call-ID: 12345600@example.com
Record-Route: <sip:proxy.example.com;lr>
History-Info: <sip:bob@example.com>;index=1
History-Info: <sip:bob@192.0.2.4?Reason=SIP%3Bcause%3D302>;\
    index=1.1;rc=1
History-Info: <sip:office@example.com>;index=1.2;mp=1
History-Info: <sip:office@192.0.2.5>;index=1.2.1;rc=1.2
CSeq: 1 INVITE
Contact: Alice <sip:alice@192.0.2.3>
Content-Type: application/sdp
Content-Length: <appropriate value>
```

[SDP Not Shown]

F7 180 Ringing office -> example.com

```
SIP/2.0 180 Ringing
Via: SIP/2.0/TCP proxy.example.com:5060;branch=z9hG4bKx4st
Via: SIP/2.0/TCP 192.0.2.3:5060;branch=z9hG4bK4321
From: Alice <sip:alice@example.com>;tag=sr3dds
To: Bob <sip:bob@example.com>;tag=53rdds
Supported: histinfo
Call-ID: 12345600@example.com
Record-Route: <sip:proxy.example.com;lr>
History-Info: <sip:bob@example.com>;index=1
History-Info: <sip:bob@192.0.2.4?Reason=SIP%3Bcause%3D302>;\
    index=1.1;rc=1
History-Info: <sip:office@example.com>;index=1.2;mp=1
History-Info: <sip:office@192.0.2.5>;index=1.2.1;rc=1.2
CSeq: 1 INVITE
Contact: Office <sip:office@192.0.2.5>
Content-Length: 0
```

F8 180 Ringing example.com -> Alice

```
SIP/2.0 180 Ringing
Via: SIP/2.0/TCP 192.0.2.3:5060;branch=z9hG4bK4321
From: Alice <sip:alice@example.com>;tag=sr3dds
To: Bob <sip:bob@example.com>;tag=53rdds
Supported: histinfo
Call-ID: 12345600@example.com
Record-Route: <sip:proxy.example.com;lr>
History-Info: <sip:bob@example.com>;index=1
History-Info: <sip:bob@192.0.2.4?Reason=SIP%3Bcause%3D302>;\
    index=1.1;rc=1
History-Info: <sip:office@example.com>;index=1.2;mp=1
History-Info: <sip:office@192.0.2.5>;index=1.2.1;rc=1.2
CSeq: 1 INVITE
Contact: Office <sip:office@192.0.2.5>
Content-Length: 0
```

F9 INVITE example.com -> home

```
INVITE sip:home@192.0.2.6 SIP/2.0
Via: SIP/2.0/TCP proxy.example.com:5060;branch=z9hG4bKx5st
Via: SIP/2.0/TCP 192.0.2.3:5060;branch=z9hG4bK4321
Max-Forwards: 69
From: Alice <sip:alice@example.com>;tag=sr3dds
To: Bob <sip:bob@example.com>
Supported: histinfo
Call-ID: 12345600@example.com
Record-Route: <sip:proxy.example.com;lr>
History-Info: <sip:bob@example.com>;index=1
History-Info: <sip:bob@192.0.2.4?Reason=SIP%3Bcause%3D302>;\
    index=1.1;rc=1
History-Info: <sip:office@example.com?Reason=SIP%3Bcause%3D408>;\
    index=1.2;mp=1
History-Info: <sip:office@192.0.2.5?Reason=SIP%3Bcause%3D408>;\
    index=1.2.1;rc=1.2
History-Info: <sip:home@example.com>;index=1.3;mp=1
History-Info: <sip:home@192.0.2.6>;index=1.3.1;rc=1.3
CSeq: 1 INVITE
Contact: Alice <sip:alice@192.0.2.3>
Content-Type: application/sdp
Content-Length: <appropriate value>
```

[SDP Not Shown]

F10 100 Trying home -> example.com

```
SIP/2.0 100 Trying
Via: SIP/2.0/TCP proxy.example.com:5060;branch=z9hG4bKx5st
Via: SIP/2.0/TCP 192.0.2.3:5060;branch=z9hG4bK4321
From: Alice <sip:alice@example.com>;tag=sr3dds
To: Bob <sip:bob@example.com>
Call-ID: 12345600@example.com
CSeq: 1 INVITE
Content-Length: 0
```

F11 486 Busy Here home -> example.com

```
SIP/2.0 486 Busy Here
Via: SIP/2.0/TCP proxy.example.com:5060;branch=z9hG4bKx5st
Via: SIP/2.0/TCP 192.0.2.3:5060;branch=z9hG4bK4321
From: Alice <sip:alice@example.com>;tag=sr3dds
To: Bob <sip:bob@example.com>;tag=55rdds
Call-ID: 12345600@example.com
History-Info: <sip:bob@example.com>;index=1
History-Info: <sip:bob@192.0.2.4?Reason=SIP%3Bcause%3D302>;\
    index=1.1;rc=1
History-Info: <sip:office@example.com?Reason=SIP%3Bcause%3D408>;\
    index=1.2;mp=1
History-Info: <sip:office@192.0.2.5?Reason=SIP%3Bcause%3D408>;\
    index=1.2.1;rc=1.2
History-Info: <sip:home@example.com>;index=1.3;mp=1
History-Info: <sip:home@192.0.2.6>;index=1.3.1;rc=1.3
CSeq: 1 INVITE
Content-Length: 0
```

F12 486 Busy Here example.com -> Alice

```
SIP/2.0 486 Busy Here
Via: SIP/2.0/TCP 192.0.2.3:5060;branch=z9hG4bK4321
From: Alice <sip:alice@example.com>;tag=sr3dds
To: Bob <sip:bob@example.com>;tag=55rdds
Call-ID: 12345600@example.com
History-Info: <sip:bob@example.com>;index=1
History-Info: <sip:bob@192.0.2.4?Reason=SIP%3Bcause%3D302>;\
    index=1.1;rc=1
History-Info: <sip:office@example.com?Reason=SIP%3Bcause%3D408>;\
    index=1.2;mp=1
History-Info: <sip:office@192.0.2.5?Reason=SIP%3Bcause%3D408>;\
    index=1.2.1;rc=1.2
History-Info: <sip:home@example.com>;index=1.3;mp=1
History-Info: <sip:home@192.0.2.6>;index=1.3.1;rc=1.3
CSeq: 1 INVITE
Content-Length: 0
```

F13 ACK example.com -> home

```
ACK sip:home@192.0.2.6 SIP/2.0
Via: SIP/2.0/TCP proxy.example.com:5060;branch=z9hG4bKx5st
Max-Forwards: 70
From: Alice <sip:alice@example.com>;tag=sr3dds
To: Bob <sip:bob@example.com>;tag=55rdds
Call-ID: 12345600@example.com
CSeq: 1 ACK
Content-Length: 0
```

F14 ACK Alice -> example.com

```
ACK sip:bob@example.com SIP/2.0
Via: SIP/2.0/TCP 192.0.2.3:5060;branch=z9hG4bK4321
Max-Forwards: 70
From: Alice <sip:alice@example.com>;tag=sr3dds
To: Bob <sip:bob@example.com>;tag=55rdds
Call-ID: 12345600@example.com
Route: <sip:proxy.example.com;lr>
CSeq: 1 ACK
Content-Length: 0
```

3.2. History-Info with Privacy Header Field

This is an example of the use of the Privacy header field with a value of "history" added by an intermediary. The intermediary responsible for the biloxi.example.com domain adds a Privacy header field with a value of "history" indicating that all the History-Info header field information is anonymized outside the biloxi.example.com domain.

Alice atlanta.example.com biloxi.example.com Bob Work Bob Home

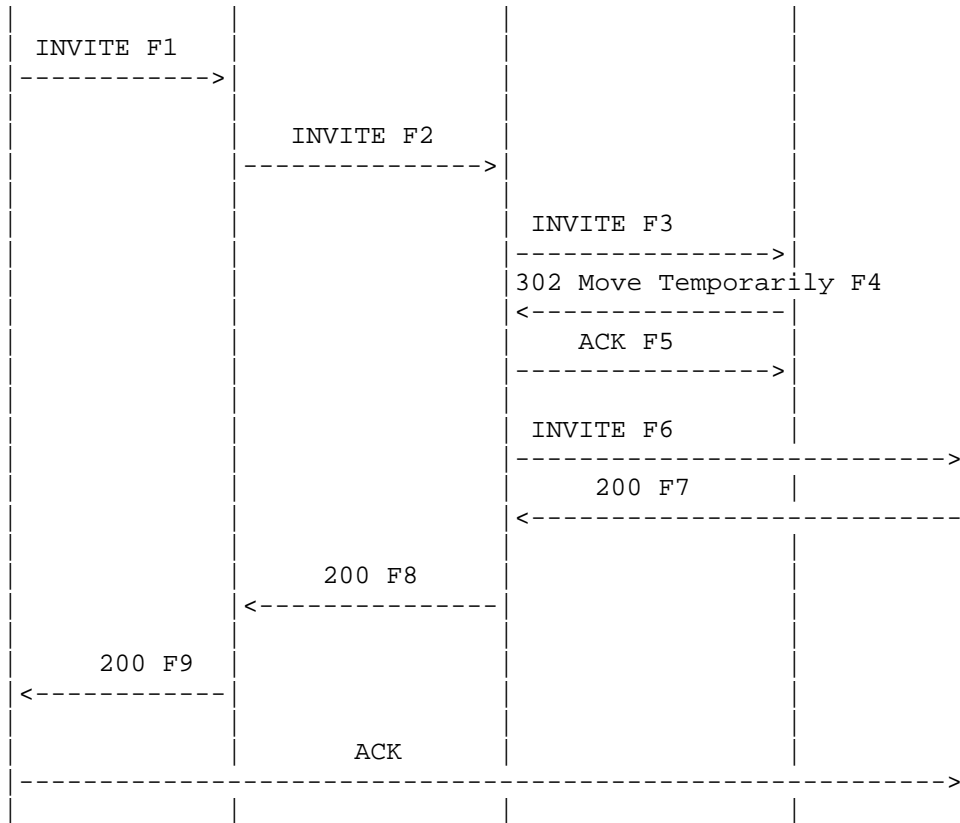

Figure 2: Example with Privacy Header Fields

Message Details

F1 INVITE Alice -> atlanta.example.com

```
INVITE sip:bob@biloxi.example.com;p=x SIP/2.0
Via: SIP/2.0/TCP 192.0.2.3:5060;branch=z9hG4bK4321
Max-Forwards: 70
From: Alice <sip:alice@atlanta.example.com>;tag=22
To: Bob <sip:bob@biloxi.example.com>
Supported: histinfo
Privacy: history
Call-ID: 12345600@atlanta.example.com
CSeq: 1 INVITE
History-Info: <sip:bob@biloxi.example.com;p=x>;index=1
Contact: Alice <sip:alice@192.0.2.3>
Content-Type: application/sdp
Content-Length: <appropriate value>
```

[SDP Not Shown]

F2 INVITE atlanta.example.com -> biloxi.example.com

```
INVITE sip:bob@biloxi.example.com;p=x SIP/2.0
Via: SIP/2.0/TCP proxy.atlanta.example.com:5060;branch=z9hG4bKbst2
Via: SIP/2.0/TCP 192.0.2.3:5060;branch=z9hG4bK4321
Max-Forwards: 69
From: Alice <sip:alice@atlanta.example.com>;tag=22
To: Bob <sip:bob@biloxi.example.com>
Supported: histinfo
Call-ID: 12345600@atlanta.example.com
CSeq: 1 INVITE
History-Info: <sip:bob@biloxi.example.com;p=x>;index=1
History-Info: <sip:bob@biloxi.example.com;p=x>;index=1.1
Contact: Alice <sip:alice@192.0.2.3>
Content-Type: application/sdp
Content-Length: <appropriate value>
```

[SDP Not Shown]

F3 INVITE biloxi.example.com -> Bob Work

```
INVITE sip:bob@192.0.1.11 SIP/2.0
Via: SIP/2.0/TCP proxy.biloxi.example.com:5060;branch=z9hG4bKgs33
Via: SIP/2.0/TCP proxy.atlanta.example.com:5060;branch=z9hG4bKbst2;\
    received=192.0.2.3
Via: SIP/2.0/TCP 192.0.2.3:5060;branch=z9hG4bK4321
Max-Forwards: 68
From: Alice <sip:alice@atlanta.example.com>;tag=22
To: Bob <sip:bob@biloxi.example.com>
Privacy: history
Supported: histinfo
Call-ID: 12345600@atlanta.example.com
CSeq: 1 INVITE
History-Info: <sip:bob@biloxi.example.com;p=x>;index=1
History-Info: <sip:bob@biloxi.example.com;p=x>;index=1.1
History-Info: <sip:bob@192.0.1.11>;index=1.1.1;rc=1.1
Contact: Alice <sip:alice@192.0.2.3>
Content-Type: application/sdp
Content-Length: <appropriate value>
```

[SDP Not Shown]

F4 302 Moved Temporarily Bob Work -> biloxi.example.com

```
SIP/2.0 302 Moved Temporarily
Via: SIP/2.0/TCP proxy.biloxi.example.com:5060;branch=z9hG4bKgs33;\
    received=192.0.2.102
Via: SIP/2.0/TCP proxy.atlanta.example.com:5060;branch=z9hG4bKbst2;\
    received=192.0.2.3
Via: SIP/2.0/TCP 192.0.2.3:5060;branch=z9hG4bK4321
From: Alice <sip:alice@atlanta.example.com>;tag=22
To: Bob <sip:bob@biloxi.example.com>;tag=11
Privacy: history
Supported: histinfo
Call-ID: 12345600@atlanta.example.com
CSeq: 1 INVITE
History-Info: <sip:bob@biloxi.example.com;p=x>;index=1
History-Info: <sip:bob@biloxi.example.com;p=x>;index=1.1
History-Info: <sip:bob@192.0.1.11>;index=1.1.1;rc=1.1
Contact: Bob Home <sip:bob@192.0.1.15>
Content-Type: application/sdp
Content-Length: <appropriate value>
```

[SDP Not Shown]

F5 ACK biloxi.example.com -> Bob Work

```
ACK sip:bob@192.0.1.11 SIP/2.0
Via: SIP/2.0/TCP proxy.biloxi.example.com:5060;branch=z9hG4bKgs33
Via: SIP/2.0/TCP proxy.atlanta.example.com:5060;branch=z9hG4bKbst2;\
    received=192.0.2.3
Via: SIP/2.0/TCP 192.0.2.3:5060;branch=z9hG4bK4321
Max-Forwards: 68
From: Alice <sip:alice@atlanta.example.com>;tag=22
To: Bob <sip:bob@biloxi.example.com>;tag=11
Call-ID: 12345600@atlanta.example.com
CSeq: 1 ACK
Content-Length: <appropriate value>
```

[SDP Not Shown]

F6 INVITE biloxi.example.com -> Bob Home

```
INVITE sip:bob@192.0.1.15 SIP/2.0
Via: SIP/2.0/TCP proxy.biloxi.example.com:5060;branch=z9hG4bKgs32
Via: SIP/2.0/TCP proxy.atlanta.example.com:5060;branch=z9hG4bKbst2;\
    received=192.0.2.3
Via: SIP/2.0/TCP 192.0.2.3:5060;branch=z9hG4bK4321
Max-Forwards: 68
From: Alice <sip:alice@atlanta.example.com>;tag=22
To: Bob <sip:bob@biloxi.example.com>
Privacy: history
Supported: histinfo
Call-ID: 12345600@atlanta.example.com
CSeq: 1 INVITE
History-Info: <sip:bob@biloxi.example.com;p=x>;index=1
History-Info: <sip:bob@biloxi.example.com;p=x>;index=1.1
History-Info: <sip:bob@192.0.1.11?Reason=SIP%3Bcause%3D302>;\
    index=1.1.1;rc=1
History-Info: <sip:bob@192.0.1.15>;index=1.1.2
Contact: Alice <sip:alice@192.0.2.3>
Content-Type: application/sdp
Content-Length: <appropriate value>
```

[SDP Not Shown]

F7 200 OK Bob -> biloxi.example.com

SIP/2.0 200 OK

Via: SIP/2.0/TCP proxy.biloxi.example.com:5060;branch=z9hG4bKgs32;\nreceived=192.0.2.101

Via: SIP/2.0/TCP proxy.atlanta.example.com:5060;branch=z9hG4bKbst2;\nreceived=192.0.2.3

Via: SIP/2.0/TCP 192.0.2.3:5060;branch=z9hG4bK4321

From: Alice <sip:alice@atlanta.example.com>;tag=22

To: Bob <sip:bob@biloxi.example.com>;tag=33

Privacy: history

Supported: histinfo

Call-ID: 12345600@atlanta.example.com

CSeq: 1 INVITE

History-Info: <sip:bob@biloxi.example.com;p=x>;index=1

History-Info: <sip:bob@biloxi.example.com;p=x>;index=1.1

History-Info: <sip:bob@192.0.1.11?Reason=SIP%3Bcause%3D302>;\nindex=1.1.1;rc=1

History-Info: <sip:bob@192.0.1.15>;index=1.1.2;rc=1.1

Content-Type: application/sdp

Content-Length: <appropriate value>

[SDP Not Shown]

F8 200 OK biloxi.example.com -> atlanta.example.com

SIP/2.0 200 OK

Via: SIP/2.0/TCP proxy.atlanta.example.com:5060;branch=z9hG4bKbst2;\nreceived=192.0.2.3

Via: SIP/2.0/TCP 192.0.2.3:5060;branch=z9hG4bK4321

From: Alice <sip:alice@atlanta.example.com>;tag=22

To: Bob <sip:bob@biloxi.example.com>;tag=33

Privacy: history

Supported: histinfo

Call-ID: 12345600@atlanta.example.com

CSeq: 1 INVITE

History-Info: <sip:anonymous@anonymous.invalid>;index=1

History-Info: <sip:anonymous@anonymous.invalid>;index=1.1

History-Info: <sip:anonymous@anonymous.invalid>;index=1.1.1;rc=1

History-Info: <sip:anonymous@anonymous.invalid>;index=1.1.2;rc=1.1

Contact: Bob <sip:bob@192.0.1.11>

Content-Type: application/sdp

Content-Length: <appropriate value>

[SDP Not Shown]

F9 200 OK atlanta.example.com -> Alice

SIP/2.0 200 OK

Via: SIP/2.0/TCP 192.0.2.3:5060;branch=z9hG4bK4321

From: Alice <sip:alice@atlanta.example.com>;tag=22

To: Bob <sip:bob@biloxi.example.com>;tag=33

Privacy: history

Supported: histinfo

Call-ID: 12345600@atlanta.example.com

CSeq: 1 INVITE

History-Info: <sip:anonymous@anonymous.invalid>;index=1

History-Info: <sip:anonymous@anonymous.invalid>;index=1.1

History-Info: <sip:anonymous@anonymous.invalid>;index=1.1.1;rc=1

History-Info: <sip:anonymous@anonymous.invalid>;index=1.1.2;rc=1.1

Contact: Bob <sip:bob@192.0.1.11>

Content-Type: application/sdp

Content-Length: <appropriate value>

[SDP Not Shown]

3.3. Privacy for a Specific History-Info Entry

This example provides a basic call scenario similar to Section 3.2; however, due to local policy at sip:biloxi.example.com, only the final hi-entry in the History-Info, which is Bob's local URI, contains a privacy header field with a priv-value of "history", thus providing Alice with some information about the history of the request, but anonymizing Bob's local URI.

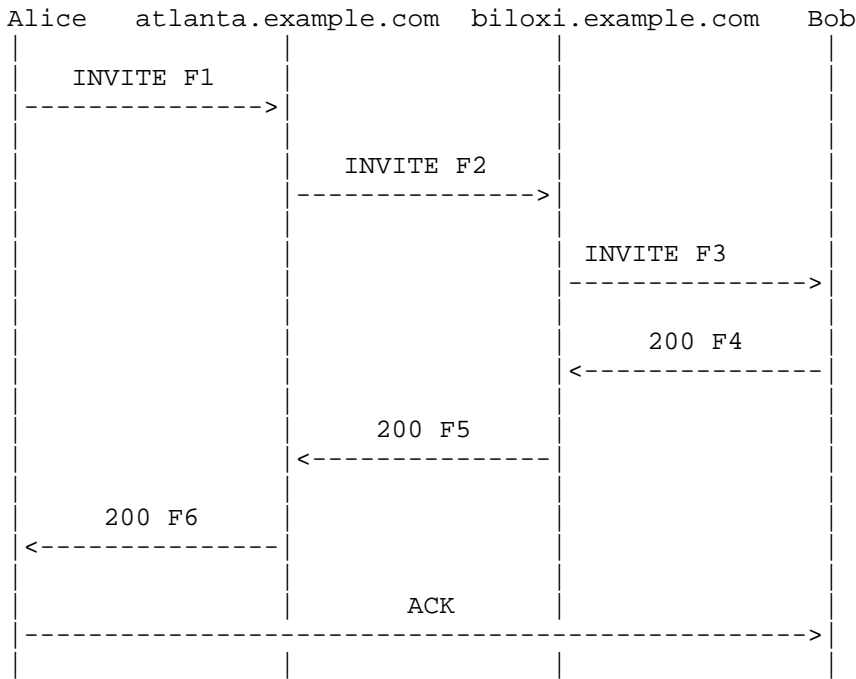

Figure 3: Example with Privacy Header Field for Specific URI

Message Details

F1 INVITE Alice -> atlanta.example.com

```

INVITE sip:bob@biloxi.example.com;p=x SIP/2.0
Via: SIP/2.0/TCP 192.0.2.3:5060;branch=z9hG4bK4321
Max-Forwards: 70
From: Alice <sip:alice@atlanta.example.com>;tag=22
To: Bob <sip:bob@biloxi.example.com>
Supported: histinfo
Call-ID: 12345600@atlanta.example.com
CSeq: 1 INVITE
History-Info: <sip:bob@biloxi.example.com;p=x>;index=1
Contact: Alice <sip:alice@192.0.2.3>
Content-Type: application/sdp
Content-Length: <appropriate value>

```

[SDP Not Shown]

F2 INVITE atlanta.example.com -> biloxi.example.com

```
INVITE sip:bob@biloxi.example.com;p=x SIP/2.0
Via: SIP/2.0/TCP proxy.atlanta.example.com:5060;branch=z9hG4bKbst2
Via: SIP/2.0/TCP 192.0.2.3:5060;branch=z9hG4bK4321
Max-Forwards: 69
From: Alice <sip:alice@atlanta.example.com>;tag=22
To: Bob <sip:bob@biloxi.example.com>
Supported: histinfo
Call-ID: 12345600@atlanta.example.com
CSeq: 1 INVITE
History-Info: <sip:bob@biloxi.example.com;p=x>;index=1
History-Info: <sip:bob@biloxi.example.com;p=x>;index=1.1;np=1
Contact: Alice <sip:alice@192.0.2.3>
Content-Type: application/sdp
Content-Length: <appropriate value>
```

[SDP Not Shown]

F3 INVITE biloxi.example.com -> Bob

```
INVITE sip:bob@192.0.1.11 SIP/2.0
Via: SIP/2.0/TCP proxy.biloxi.example.com:5060;branch=z9hG4bKreset
Via: SIP/2.0/TCP proxy.atlanta.example.com:5060;branch=z9hG4bKbst2;\
    received=192.0.2.101
Via: SIP/2.0/TCP 192.0.2.3:5060;branch=z9hG4bK4321
Max-Forwards: 68
From: Alice <sip:alice@atlanta.example.com>;tag=22
To: Bob <sip:bob@biloxi.example.com>
Supported: histinfo
Call-ID: 12345600@atlanta.example.com
CSeq: 1 INVITE
History-Info: <sip:bob@biloxi.example.com;p=x>;index=1
History-Info: <sip:bob@biloxi.example.com;p=x>;index=1.1;np=1
History-Info: <sip:bob@192.0.1.11?Privacy=history>;index=1.1.1;rc=1.1
Contact: Alice <sip:alice@192.0.2.3>
Content-Type: application/sdp
Content-Length: <appropriate value>
```

[SDP Not Shown]

F4 200 OK Bob -> biloxi.example.com

```
SIP/2.0 200 OK
Via: SIP/2.0/TCP proxy.biloxi.example.com:5060;branch=z9hG4bKeset;\
    received=192.0.2.5
Via: SIP/2.0/TCP proxy.atlanta.example.com:5060;branch=z9hG4bKbst2;\
    received=192.0.2.101
Via: SIP/2.0/TCP 192.0.2.3:5060;branch=z9hG4bK4321
From: Alice <sip:alice@atlanta.example.com>;tag=22
To: Bob <sip:bob@biloxi.example.com>;tag=33
Supported: histinfo
Call-ID: 12345600@atlanta.example.com
CSeq: 1 INVITE
History-Info: <sip:bob@biloxi.example.com;p=x>;index=1
History-Info: <sip:bob@biloxi.example.com;p=x>;index=1.1;np=1
History-Info: <sip:bob@192.0.1.11?Privacy=history>;index=1.1.1;rc=1.1
Contact: Bob <sip:bob@192.0.1.11>
Content-Type: application/sdp
Content-Length: <appropriate value>
```

[SDP Not Shown]

F5 200 OK biloxi.example.com -> atlanta.example.com

```
SIP/2.0 200 OK
Via: SIP/2.0/TCP proxy.atlanta.example.com:5060;branch=z9hG4bKbst2;\
    received=192.0.2.101
Via: SIP/2.0/TCP 192.0.2.3:5060;branch=z9hG4bK4321
From: Alice <sip:alice@atlanta.example.com>;tag=22
To: Bob <sip:bob@biloxi.example.com>;tag=33
Supported: histinfo
Call-ID: 12345600@atlanta.example.com
CSeq: 1 INVITE
History-Info: <sip:bob@biloxi.example.com;p=x>;index=1
History-Info: <sip:bob@biloxi.example.com;p=x>;index=1.1;np=1
History-Info: <sip:anonymous@anonymous.invalid>;index=1.1.1;rc=1.1
Contact: Bob <sip:bob@192.0.1.11>
Content-Type: application/sdp
Content-Length: <appropriate value>
```

[SDP Not Shown]

F6 200 OK atlanta.example.com -> Alice

```
SIP/2.0 200 OK
Via: SIP/2.0/TCP 192.0.2.3:5060;branch=z9hG4bK4321
From: Alice <sip:alice@atlanta.example.com>;tag=22
To: Bob <sip:bob@biloxi.example.com>;tag=33
Supported: histinfo
Call-ID: 12345600@atlanta.example.com
CSeq: 1 INVITE
History-Info: <sip:bob@biloxi.example.com;p=x>;index=1
History-Info: <sip:bob@biloxi.example.com;p=x>;index=1.1;np=1
History-Info: <sip:anonymous@anonymous.invalid>;index=1.1.1;rc=1.1
Contact: Bob <sip:bob@192.0.1.11>
Content-Type: application/sdp
Content-Length: <appropriate value>
```

[SDP Not Shown]

3.4. Automatic Call Distribution

This scenario highlights an example of an Automatic Call Distribution service, where the agents are divided into groups based upon the type of customers they handle. In this example, the Gold customers are given higher priority than Silver customers, so a Gold call would get serviced even if all the agents servicing the Gold group were busy, by retargeting the request to the Silver Group for delivery to an agent. Upon receipt of the call at the agent assigned to handle the incoming call, based upon the History-Info header in the message, the application at the agent can provide an indication that this is a Gold call by extracting the hi-entry associated with the incoming request, which is determined by locating the hi-entry whose index is reflected in the first hi-entry with a hi-target of "mp". In the example, this would be the hi-entry referenced by the value of the first "mp" header field parameter, i.e., the hi-entry containing an index of "1". An application can also determine how many groups from which the call may have overflowed before reaching the agent, etc., and present the information to the agent so that the call can be handled appropriately, i.e., "I'm so sorry for the delay, blah, blah, blah..."

For scenarios whereby calls might overflow from the Silver to the Gold, clearly the alternate group identification, internal routing, or actual agent that handles the call should not be sent to UA1. Thus, for this scenario, one would expect that the proxy would not support the sending of the History-Info in the response, even if requested by Alice or the proxy could anonymize the Silver related hi-entries by adding privacy in the Silver hi-entries.

As with the other examples, this is not a complete prescription of how one would do this type of service but an example of a subset of processing that might be associated with such a service. In addition, this example does not address any aspects of agent availability resulting in the call being sent to an agent in another group, which might also be done via a SIP interface.

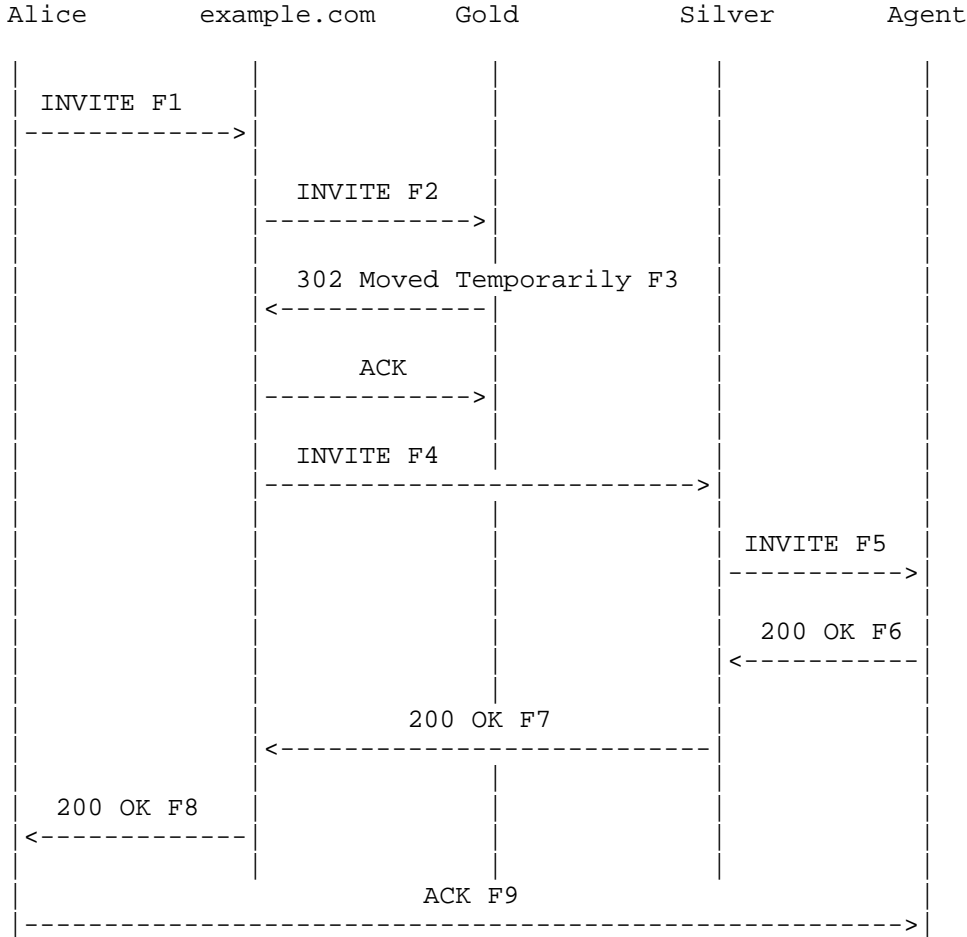

Figure 4: Example for Automatic Call Distribution

Message Details

F1 INVITE Alice -> example.com

```
INVITE sip:Gold@example.com SIP/2.0
Via: SIP/2.0/TCP 192.0.2.3:5060;branch=z9hG4bK42t2
Max-Forwards: 70
From: Alice <sip:alice@example.com>;tag=1235
To: Gold Member Assistance <sip:Gold@example.com>
Supported: histinfo
Call-ID: 12345600@example.com
CSeq: 1 INVITE
History-Info: <sip:Gold@example.com>;index=1
Contact: Alice <sip:alice@192.0.2.3>
Content-Type: application/sdp
Content-Length: <appropriate value>
```

[SDP Not Shown]

F2 INVITE example.com -> Gold.example.com

```
INVITE sip:Gold@gold.example.com SIP/2.0
Via: SIP/2.0/TCP proxy.example.com:5060;branch=z9hG4bK12s4
Via: SIP/2.0/TCP 192.0.2.3:5060;branch=z9hG4bK42t2
Max-Forwards: 69
From: Alice <sip:alice@example.com>;tag=1235
To: Gold Member Assistance <sip:Gold@example.com>
Supported: histinfo
Call-ID: 12345600@example.com
CSeq: 1 INVITE
History-Info: <sip:Gold@example.com>;index=1
History-Info: <sip:Gold@gold.example.com>;rc=1;index=1.1
Contact: Alice <sip:alice@192.0.2.3>
Content-Type: application/sdp
Content-Length: <appropriate value>
```

[SDP Not Shown]

F3 302 Moved Temporarily Gold.example.com -> example.com

```
SIP/2.0 302 Moved Temporarily
Via: SIP/2.0/TCP proxy.example.com:5060;branch=z9hG4bK12s4;\
    received=192.0.2.101
Via: SIP/2.0/TCP 192.0.2.3:5060;branch=z9hG4bK42t2
From: Alice <sip:alice@example.com>;tag=1235
To: Gold Member Assistance <sip:Gold@example.com>;tag=kkaz-
Supported: histinfo
Call-ID: 12345600@example.com
CSeq: 1 INVITE
History-Info: <sip:Gold@example.com>;index=1
History-Info: <sip:Gold@gold.example.com>;rc=1;index=1.1
Contact: <sip:Silver@example.com>;mp=1
Content-Type: application/sdp
Content-Length: <appropriate value>
```

[SDP Not Shown]

F4 INVITE example.com -> Silver.example.com

```
INVITE sip:Silver@example.com SIP/2.0
Via: SIP/2.0/TCP proxy.example.com:5060;branch=z9hG4bK45q2
Via: SIP/2.0/TCP 192.0.2.3:5060;branch=z9hG4bK42t2
Max-Forwards: 69
From: Alice <sip:alice@example.com>;tag=1235
To: Gold Member Assistance <sip:Gold@example.com>
Supported: histinfo
Call-ID: 12345600@example.com
CSeq: 1 INVITE
History-Info: <sip:Gold@example.com>;index=1
History-Info: <sip:Gold@gold.example.com?Reason=SIP%3Bcause%3D302>;\
    rc=1;index=1.1
History-Info: <sip:Silver@example.com>;index=1.2;mp=1
History-Info: <sip:Silver@silver.example.com>;index=1.2.1;rc=1.2
Contact: Alice <sip:alice@192.0.2.3>
Content-Type: application/sdp
Content-Length: <appropriate value>
```

[SDP Not Shown]

F5 INVITE Silver.example.com -> Agent

```
INVITE sip:Silver@192.0.2.7 SIP/2.0
Via: SIP/2.0/TCP silver.example.com:5060;branch=z9hG4bKerxs
Via: SIP/2.0/TCP proxy.example.com:5060;branch=z9hG4bK45q2;\
    received=192.0.2.101
Via: SIP/2.0/TCP 192.0.2.3:5060;branch=z9hG4bK42t2
Max-Forwards: 68
From: Alice <sip:alice@example.com>;tag=1235
To: Gold Member Assistance <sip:Gold@example.com>
Supported: histinfo
Call-ID: 12345600@example.com
CSeq: 1 INVITE
History-Info: <sip:Gold@example.com>;index=1
History-Info: <sip:Gold@gold.example.com?Reason=SIP%3Bcause%3D302>;\
    rc=1;index=1.1
History-Info: <sip:Silver@example.com>;index=1.2;mp=1
History-Info: <sip:Silver@silver.example.com>;index=1.2.1;rc=1.2
History-Info: <sip:Silver@192.0.2.7>;index=1.2.1.1;rc=1.2.1
Contact: Alice <sip:alice@192.0.2.3>
Content-Type: application/sdp
Content-Length: <appropriate value>
```

[SDP Not Shown]

F6 200 OK Agent -> Silver.example.com

```
SIP/2.0 200 OK
Via: SIP/2.0/TCP silver.example.com:5060;branch=z9hG4bKerxs;\
    received=192.0.2.5
Via: SIP/2.0/TCP proxy.example.com:5060;branch=z9hG4bK45q2;\
    received=192.0.2.101
Via: SIP/2.0/TCP 192.0.2.3:5060;branch=z9hG4bK42t2
From: Alice <sip:alice@example.com>;tag=1235
To: Gold Member Assistance <sip:Gold@example.com>;tag=2325
Supported: histinfo
Call-ID: 12345600@example.com
CSeq: 1 INVITE
History-Info: <sip:Gold@example.com>;index=1
History-Info: <sip:Gold@gold.example.com?Reason=SIP%3Bcause%3D302>;\
    rc=1;index=1.1
History-Info: <sip:Silver@example.com>;index=1.2;mp=1
History-Info: <sip:Silver@silver.example.com>;index=1.2.1;rc=1.2
History-Info: <sip:Silver@192.0.2.7>;index=1.2.1.1;rc=1.2.1
Contact: Agent <sip:Silver@192.0.2.7>
Content-Type: application/sdp
Content-Length: <appropriate value>
```

[SDP Not Shown]

F7 200 OK Silver.example.com -> example.com

```
SIP/2.0 200 OK
Via: SIP/2.0/TCP proxy.example.com:5060;branch=z9hG4bK45q2;\
    received=192.0.2.101
Via: SIP/2.0/TCP 192.0.2.3:5060;branch=z9hG4bK42t2
From: Alice <sip:alice@example.com>;tag=1235
To: Gold Member Assistance <sip:Gold@example.com>;tag=2325
Supported: histinfo
Call-ID: 12345600@example.com
CSeq: 1 INVITE
History-Info: <sip:Gold@example.com>;index=1
History-Info: <sip:Gold@gold.example.com?Reason=SIP%3Bcause%3D302>;\
    rc=1;index=1.1
History-Info: <sip:Silver@example.com>;index=1.2;mp=1
History-Info: <sip:Silver@silver.example.com>;index=1.2.1;rc=1.2
History-Info: <sip:Silver@192.0.2.7>;index=1.2.1.1;rc=1.2.1
Contact: Agent <sip:Silver@192.0.2.7>
Content-Type: application/sdp
Content-Length: <appropriate value>
```

[SDP Not Shown]

F8 200 OK example.com -> Alice

```
SIP/2.0 200 OK
Via: SIP/2.0/TCP 192.0.2.3:5060;branch=z9hG4bK42t2
From: Alice <sip:alice@example.com>;tag=1235
To: Gold Member Assistance <sip:Gold@example.com>;tag=2325
Supported: histinfo
Call-ID: 12345600@example.com
CSeq: 1 INVITE
History-Info: <sip:Gold@example.com>;index=1
History-Info: <sip:Gold@gold.example.com?Reason=SIP%3Bcause%3D302>;\
    rc=1;index=1.1
History-Info: <sip:Silver@example.com>;index=1.2;mp=1
History-Info: <sip:Silver@silver.example.com>;index=1.2.1;rc=1.2
History-Info: <sip:Silver@192.0.2.7>;index=1.2.1.1;rc=1.2.1
Contact: Agent <sip:Silver@192.0.2.7>
Content-Type: application/sdp
Content-Length: <appropriate value>
```

[SDP Not Shown]

F9 ACK Alice -> Agent

```
ACK sip:Silver@192.0.2.7 SIP/2.0
Via: SIP/2.0/TCP 192.0.2.3:5060;branch=z9hG4bK42t3
Max-Forwards: 70
From: Alice <sip:alice@example.com>;tag=1235
To: Gold Member Assistance <sip:Gold@example.com>;tag=2325
Supported: histinfo
Call-ID: 12345600@example.com
CSeq: 1 ACK
Contact: Alice <sip:alice@192.0.2.3>
Content-Type: application/sdp
Content-Length: <appropriate value>
```

[SDP Not Shown]

The first hi-entry with the "mp" header field parameter contains an "mp" header field parameter value of 1, which points to the original-target, which allows the operator to identify that the call was from the Gold customer.

3.5. Determining the Alias Used

SIP UAs are associated with an AOR. It is possible for a single UA to actually have multiple AORs associated with it. One common usage for this is aliases. For example, a user might have an AOR of sip:john@example.com but also have the AORs sip:john.smith@example.com and sip:jsmith@example.com. Rather than registering against each of these AORs individually, the user would register against just one of them, and the home proxy would automatically accept incoming calls for any of the aliases, treating them identically and ultimately forwarding them towards the UA. This is common practice in the IP Multimedia Subsystem (IMS), where it is called "implicit registration" and each alias is called a "public user identity (PUID)".

It is a common requirement for a User Agent Server (UAS), on receipt of a call, to know which of its aliases was used to reach it. This knowledge can be used to choose ringtones to play, determine call treatment, and so on. For example, a user might give out one alias to friends and family only, resulting in a special ring that alerts the user to the importance of the call.

The following call flow and example messages show how History-Info can be used to find out the alias used to reach the callee. The alias for the call is determined by hi-entry with the index that matches the value of the last hi-entry with an "rc" header field parameter in the Request received.

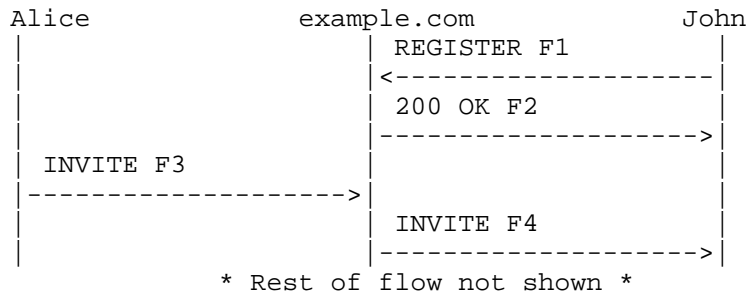

Figure 5: Alias Example

Message Details

F1 REGISTER John -> example.com

```
REGISTER sip:example.com SIP/2.0
Via: SIP/2.0/TCP 192.0.2.1;branch=z9hG4bKnashds7
Max-Forwards: 70
From: John <sip:john@example.com>;tag=a73kszlfl
To: John <sip:john@example.com>
Supported: histinfo
Call-ID: 1j9FpLxk3uxtm8tn@192.0.2.1
CSeq: 1 REGISTER
Contact: <sip:john@192.0.2.1>
Content-Length: 0
```

F2 200 OK example.com -> John

```
SIP/2.0 200 OK
Via: SIP/2.0/TCP 192.0.2.1;branch=z9hG4bKnashds7
From: John <sip:john@example.com>;tag=a73kszlfl
To: John <sip:john@example.com>;tag=d2dstee2
Call-ID: 1j9FpLxk3uxtm8tn@192.0.2.1
CSeq: 1 REGISTER
Contact: <sip:john@192.0.2.1>;expires=3600
Content-Length: 0
```

F3 INVITE Alice -> example.com

```
INVITE sip:john.smith@example.com SIP/2.0
Via: SIP/2.0/TCP 192.0.2.3:5060;branch=z9hG4bK42t2
Max-Forwards: 70
From: Alice <sip:alice@example.com>;tag=a73kszlfl
To: John <sip:john.smith@example.com>
Supported: histinfo
Call-ID: 12345600@example.com
CSeq: 1 INVITE
History-Info: <sip:john.smith@example.com>;index=1
Contact: Alice <sip:alice@192.0.2.3>
Content-Type: application/sdp
Content-Length: <appropriate value>
```

[SDP Not Shown]

F4 INVITE example.com -> John

```
INVITE sip:john@192.0.2.1 SIP/2.0
Via: SIP/2.0/TCP proxy.example.com:5060;branch=z9hG4bK12s4
Via: SIP/2.0/TCP 192.0.2.3:5060;branch=z9hG4bK42t2
Max-Forwards: 69
From: Alice <sip:alice@example.com>;tag=a73kszlfl
To: John <sip:john.smith@example.com>
Supported: histinfo
Call-ID: 12345600@example.com
CSeq: 1 INVITE
Record-Route: <sip:proxy.example.com;lr>
History-Info: <sip:john.smith@example.com>;index=1
History-Info: <sip:john@192.0.2.1>;index=1.1;rc=1
Contact: Alice <sip:alice@192.0.2.3>
Content-Type: application/sdp
Content-Length: <appropriate value>
```

[SDP Not Shown]

The last hi-entry with the "rc" header field parameter references the source of retargeting pointing at the alias AOR, which in the example is "john.smith@example.com".

3.6. PBX Voicemail Example

A typical use case for voicemail is one whereby the original called party is not reachable and the call arrives at a voicemail system. In some cases, multiple alternate destinations may be tried without success. The voicemail system typically requires the original called party information to determine the appropriate mailbox so an appropriate greeting can be provided and the appropriate party notified of the message.

In this example, Alice calls Bob, whose SIP client is forwarded to Carol. Carol does not answer the call; thus, it is forwarded to a VM (voicemail) server (VMS). In order to determine the appropriate mailbox to use for this call, the VMS needs the original target for the request. The original target is determined by finding the first hi-entry tagged with "rc" or "mp" and using the hi-entry referenced by the index of "rc" or "mp" header field parameter as the target for determining the appropriate mailbox. This hi-entry is used to populate the "target" URI parameter as defined in [RFC4458]. The reason associated with the first hi-entry tagged with "rc" or "mp" (i.e., 302) could be used to provide a customized voicemail greeting and is used to populate the "cause" URI parameter as defined in [RFC4458]. Note that some VMSs may also (or instead) use the

information available in the History-Info headers for custom handling of the VM based on how and why the call arrived at the VMS.

Furthermore, it is the proxy forwarding the call to the VMS that determines the target of the voicemail; it is the proxy that sets the target of voicemail, which is also the entity that utilizes [RFC7044] to find the target that is usually based on local policy installed by the user or an administrator.

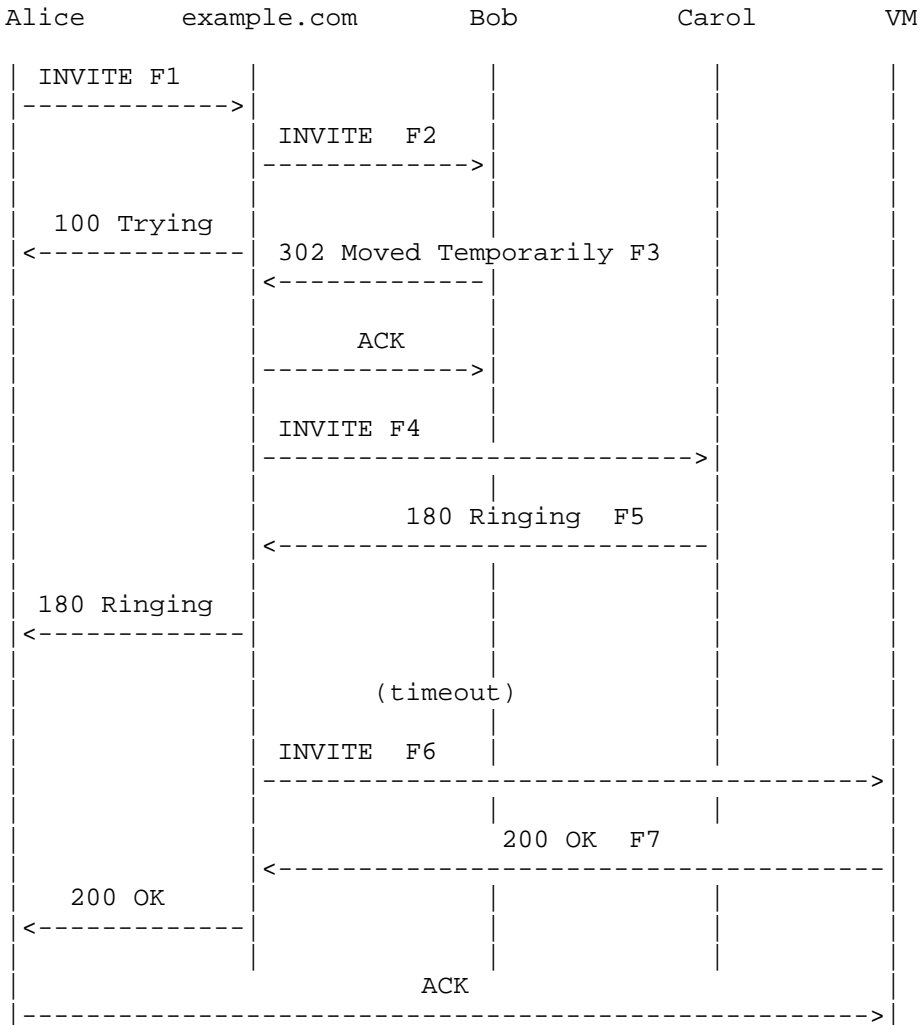

Figure 6: Enterprise Voicemail Example

Message Details

F1 INVITE Alice -> example.com

```
INVITE sip:bob@example.com SIP/2.0
Via: SIP/2.0/TCP 192.0.2.3:5060;branch=z9hG4bK42t2
Max-Forwards: 70
From: Alice <sip:alice@example.com>;tag=kkaz-
To: Bob <sip:bob@example.com>
Supported: histinfo
Call-ID: 12345600@example.com
CSeq: 1 INVITE
History-Info: <sip:bob@example.com>;index=1
Contact: Alice <sip:alice@192.0.2.3>
Content-Length: <appropriate value>
```

[SDP Not Shown]

F2 INVITE example.com -> Bob

```
INVITE sip:bob@192.0.2.5 SIP/2.0
Via: SIP/2.0/TCP proxy.example.com:5060;branch=z9hG4bK12s4
Via: SIP/2.0/TCP 192.0.2.3:5060;branch=z9hG4bK42t2
Max-Forwards: 69
From: Alice <sip:alice@example.com>;tag=kkaz-
To: Bob <sip:bob@example.com>
Supported: histinfo
Call-ID: 12345600@example.com
CSeq: 1 INVITE
History-Info: <sip:bob@example.com>;index=1
History-Info: <sip:bob@192.0.2.5>;index=1.1;rc=1
Contact: Alice <sip:alice@192.0.2.3>
Content-Type: application/sdp
Content-Length: <appropriate value>
```

[SDP Not Shown]

F3 302 Moved Temporarily Bob -> example.com

```
SIP/2.0 302 Moved Temporarily
Via: SIP/2.0/TCP proxy.example.com:5060;branch=z9hG4bK12s4;\
    received=192.0.2.101
Via: SIP/2.0/TCP 192.0.2.3:5060;branch=z9hG4bK42t2
From: Alice <sip:alice@example.com>;tag=kkaz-
To: Bob <sip:bob@example.com>;tag=2g22d-lnf
Supported: histinfo
Call-ID: 12345600@example.com
CSeq: 1 INVITE
History-Info: <sip:bob@example.com>;index=1
History-Info: <sip:bob@192.0.2.5>;index=1.1;rc=1
Contact: <sip:carol@example.com>;mp=1
Content-Type: application/sdp
Content-Length: <appropriate value>
```

[SDP Not Shown]

F4 INVITE example.com -> Carol

```
INVITE sip:carol@192.0.2.4 SIP/2.0
Via: SIP/2.0/TCP proxy.example.com:5060;branch=z9hG4bK4522
Via: SIP/2.0/TCP 192.0.2.3:5060;branch=z9hG4bK42t2
Max-Forwards: 69
From: Alice <sip:alice@example.com>;tag=kkaz-
To: Bob <sip:bob@example.com>
Supported: histinfo
Call-ID: 12345600@example.com
CSeq: 1 INVITE
History-Info: <sip:bob@example.com>;index=1
History-Info: <sip:bob@192.0.2.5?Reason=SIP%3Bcause%3D302>;\
    index=1.1;rc=1
History-Info: <sip:carol@example.com;cause=480>;index=1.2;mp=1
History-Info: <sip:carol@192.0.2.4;cause=480>;index=1.2.1;rc=1.2
Contact: Alice <sip:alice@192.0.2.3>
Content-Type: application/sdp
Content-Length: <appropriate value>
```

[SDP Not Shown]

F5 180 Ringing Carol -> example.com

SIP/2.0 180 Ringing

Via: SIP/2.0/TCP proxy.example.com:5060;branch=z9hG4bK4522;\
received=192.0.2.101

Via: SIP/2.0/TCP 192.0.2.3:5060;branch=z9hG4bK42t2

From: Alice <sip:alice@example.com>;tag=kkaz-

To: Bob <sip:bob@example.com>;tag=setss3x

Supported: histinfo

Call-ID: 12345600@example.com

CSeq: 1 INVITE

History-Info: <sip:bob@example.com>;index=1

History-Info: <sip:bob@192.0.2.5?Reason=SIP%3Bcause%3D302>;\
index=1.1;rc=1

History-Info: <sip:carol@example.com;cause=480>;index=1.2;mp=1

History-Info: <sip:carol@192.0.2.4;cause=480>;index=1.2.1;rc=1.2

Contact: <sip:carol@192.0.2.4>

Content-Type: application/sdp

Content-Length: <appropriate value>

[SDP Not Shown]

F6 INVITE example.com -> VM

```
INVITE sip:vm@192.0.2.6;target=sip:bob%40example.com;cause=480\  
      SIP/2.0  
Via: SIP/2.0/TCP proxy.example.com:5060;branch=z9hG4bK4523  
Via: SIP/2.0/TCP 192.0.2.3:5060;branch=z9hG4bK42t2  
Max-Forwards: 69  
From: Alice <sip:alice@example.com>;tag=kkaz-  
To: Bob <sip:bob@example.com>  
Supported: histinfo  
Call-ID: 12345600@example.com  
CSeq: 1 INVITE  
History-Info: <sip:bob@example.com>;index=1  
History-Info: <sip:bob@192.0.2.5?Reason=SIP%3Bcause%3D302>;\  
      index=1.1;rc=1  
History-Info: <sip:carol@example.com;cause=480?Reason=SIP%3Bcause%3D\  
      408>;index=1.2;mp=1  
History-Info: <sip:carol@192.0.2.4;cause=480?Reason=SIP%3Bcause%3D\  
      408>;index=1.2.1;rc=1.2  
History-Info: <sip:vm@example.com;\  
      target=sip:bob%40example.com;cause=480>;\  
      index=1.3;mp=1  
History-Info: <sip:vm@192.0.2.6;\  
      target=sip:bob%40example.com;cause=480>;\  
      index=1.3.1;rc=1.3  
Contact: Alice <sip:alice@192.0.2.3>  
Content-Type: application/sdp  
Content-Length: <appropriate value>
```

[SDP Not Shown]

F7 200 OK VM -> example.com

SIP/2.0 200 OK

Via: SIP/2.0/TCP proxy.example.com:5060;branch=z9hG4bK4523;\
received=192.0.2.101

Via: SIP/2.0/TCP 192.0.2.3:5060;branch=z9hG4bK42t2

From: Alice <sip:alice@example.com>;tag=kkaz-

To: Bob <sip:bob@example.com>;tag=3dweggs

Supported: histinfo

Call-ID: 12345600@example.com

CSeq: 1 INVITE

History-Info: <sip:bob@example.com>;index=1

History-Info: <sip:bob@192.0.2.5?Reason=SIP%3Bcause%3D302>;\
index=1.1;rc=1

History-Info: <sip:carol@example.com;cause=480?Reason=SIP%3Bcause%3D\
408>;index=1.2;mp=1

History-Info: <sip:carol@192.0.2.4;cause=480?Reason=SIP%3Bcause%3D\
408>;index=1.2.1;rc=1.2

History-Info: <sip:vm@example.com;\
target=sip:bob%40example.com;cause=480>;\
index=1.3;mp=1

History-Info: <sip:vm@192.0.2.6;\
target=sip:bob%40example.com;cause=480>;\
index=1.3.1;rc=1.3

Contact: <sip:vm@192.0.2.6>

Content-Type: application/sdp

Content-Length: <appropriate value>

[SDP Not Shown]

The VMS can look at the last hi-entry and find the target of the mailbox by looking at the URI entry in the "target" URI parameter in the hi-entry.

3.7. Consumer Voicemail Example

In the case of a consumer, when the call is retargeted, it is usually to another administrative domain. The voicemail system in these environments typically requires the last-called-party information to determine the appropriate mailbox so an appropriate greeting can be provided and the appropriate party notified of the message.

In this example, Alice calls Bob, but Bob has temporarily forwarded his phone to Carol (she is his wife). Carol does not answer the call; thus, it is forwarded to a VMS. In order to determine the appropriate mailbox to use for this call, the VMS needs the appropriate target for the request. The last target is determined by finding the hi-entry referenced by the index of last hi-entry tagged

with "mp" for determining the appropriate mailbox. This hi-entry is used to populate the "target" URI parameter as defined in [RFC4458]. Note that some VMSs may also (or instead) use the information available in the History-Info headers for custom handling of the VM in terms of how and why the called arrived at the VMS.

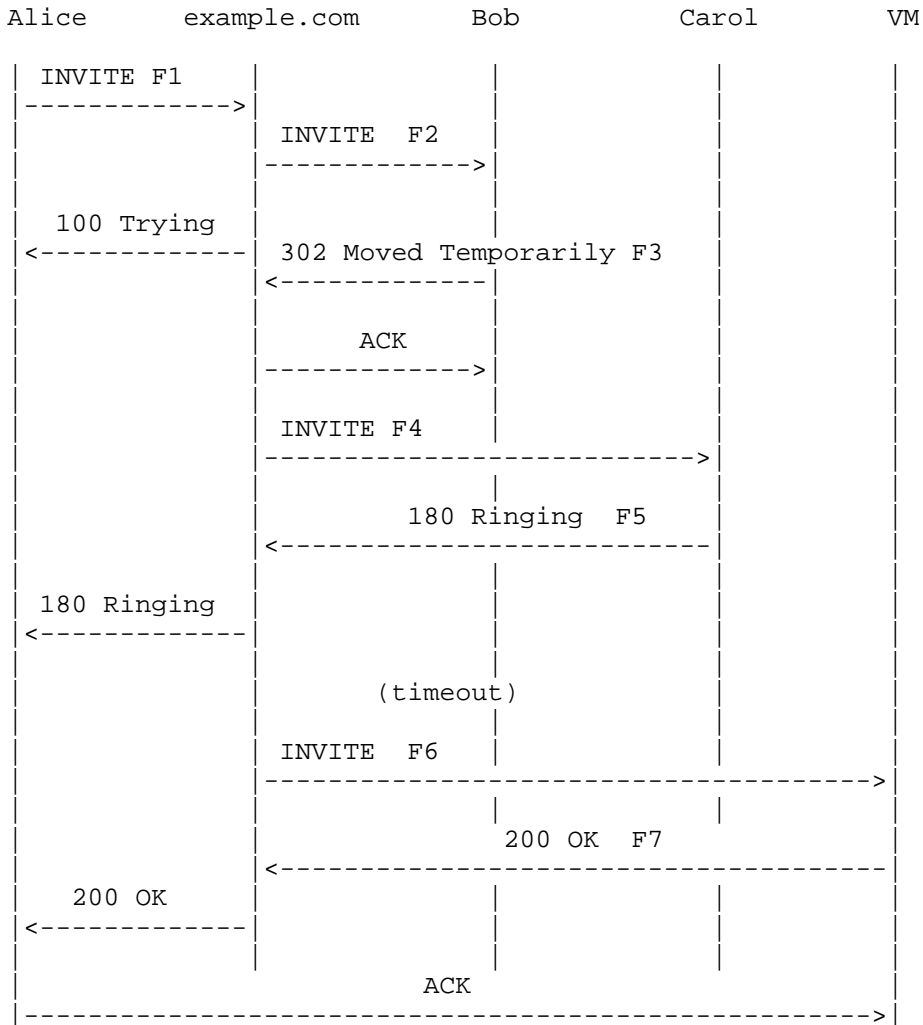

Figure 7: Consumer Voicemail Example

Message Details

F1 INVITE Alice -> example.com

```
INVITE sip:bob@example.com SIP/2.0
Via: SIP/2.0/TCP 192.0.2.3:5060;branch=z9hG4bK42t2
Max-Forwards: 70
From: Alice <sip:alice@example.com>;tag=kkaz-
To: Bob <sip:bob@example.com>
Supported: histinfo
Call-ID: 12345600@example.com
CSeq: 1 INVITE
History-Info: <sip:bob@example.com>;index=1
Contact: Alice <sip:alice@192.0.2.3>
Content-Length: <appropriate value>
```

[SDP Not Shown]

F2 INVITE example.com -> Bob

```
INVITE sip:bob@192.0.2.5 SIP/2.0
Via: SIP/2.0/TCP proxy.example.com:5060;branch=z9hG4bK12s4
Via: SIP/2.0/TCP 192.0.2.3:5060;branch=z9hG4bK42t2
Max-Forwards: 69
From: Alice <sip:alice@example.com>;tag=kkaz-
To: Bob <sip:bob@example.com>
Supported: histinfo
Call-ID: 12345600@example.com
CSeq: 1 INVITE
History-Info: <sip:bob@example.com>;index=1
History-Info: <sip:bob@192.0.2.5>;index=1.1;rc=1
Contact: Alice <sip:alice@192.0.2.3>
Content-Type: application/sdp
Content-Length: <appropriate value>
```

[SDP Not Shown]

F3 302 Moved Temporarily Bob -> example.com

```
SIP/2.0 302 Moved Temporarily
Via: SIP/2.0/TCP proxy.example.com:5060;branch=z9hG4bK12s4;\
    received=192.0.2.101
Via: SIP/2.0/TCP 192.0.2.3:5060;branch=z9hG4bK42t2
From: Alice <sip:alice@example.com>;tag=kkaz-
To: Bob <sip:bob@example.com>;tag=224ls3s-t
Supported: histinfo
Call-ID: 12345600@example.com
CSeq: 1 INVITE
History-Info: <sip:bob@example.com>;index=1
History-Info: <sip:bob@192.0.2.5>;index=1.1;rc=1
Contact: <sip:carol@example.com>;mp=1
Content-Type: application/sdp
Content-Length: <appropriate value>
```

[SDP Not Shown]

F4 INVITE example.com -> Carol

```
INVITE sip:carol@192.0.2.4 SIP/2.0
Via: SIP/2.0/TCP proxy.example.com:5060;branch=z9hG4bK24s5
Via: SIP/2.0/TCP 192.0.2.3:5060;branch=z9hG4bK42t2
Max-Forwards: 69
From: Alice <sip:alice@example.com>;tag=kkaz-
To: Bob <sip:bob@example.com>
Supported: histinfo
Call-ID: 12345600@example.com
CSeq: 1 INVITE
History-Info: <sip:bob@example.com>;index=1
History-Info: <sip:bob@192.0.2.5?Reason=SIP%3Bcause%3D302\
    %3Btext%3D%22Moved%20Temporarily%22>\
    ;index=1.1;rc=1
History-Info: <sip:carol@example.com>;index=1.2;mp=1
History-Info: <sip:carol@192.0.2.4>;index=1.2.1;rc=1.2
Contact: Alice <sip:alice@192.0.2.3>
Content-Type: application/sdp
Content-Length: <appropriate value>
```

[SDP Not Shown]

F5 180 Ringing Carol -> example.com

SIP/2.0 180 Ringing

Via: SIP/2.0/TCP proxy.example.com:5060;branch=z9hG4bK24s5;\
received=192.0.2.101

Via: SIP/2.0/TCP 192.0.2.3:5060;branch=z9hG4bK42t2

From: Alice <sip:alice@example.com>;tag=kkaz-

To: Bob <sip:bob@example.com>;tag=setss3x

Supported: histinfo

Call-ID: 12345600@example.com

CSeq: 1 INVITE

History-Info: <sip:bob@example.com>;index=1

History-Info: <sip:bob@192.0.2.5?Reason=SIP%3Bcause%3D302\
%3Btext%3D%22Moved%20Temporarily%22>;\
index=1.1;rc=1

History-Info: <sip:carol@example.com>;index=1.2;mp=1

History-Info: <sip:carol@192.0.2.4>;index=1.2.1;rc=1.2

Contact: <sip:carol@192.0.2.4>

Content-Type: application/sdp

Content-Length: <appropriate value>

[SDP Not Shown]

F6 INVITE example.com -> VM

```
INVITE sip:vm@192.0.2.6;target=sip:carol%40example.com SIP/2.0
Via: SIP/2.0/TCP proxy.example.com:5060;branch=z9hG4bKbbg4
Via: SIP/2.0/TCP 192.0.2.3:5060;branch=z9hG4bK42t2
Max-Forwards: 69
From: Alice <sip:alice@example.com>;tag=kkaz-
To: Bob <sip:bob@example.com>
Supported: histinfo
Call-ID: 12345600@example.com
CSeq: 1 INVITE
History-Info: <sip:bob@example.com>;index=1
History-Info: <sip:bob@192.0.2.5?Reason=SIP%3Bcause%3D302\
%3Btext%3D%22Moved%20Temporarily%22>;\
index=1.1;rc=1
History-Info: <sip:carol@example.com>;\
index=1.2;mp=1
History-Info: <sip:carol@192.0.2.4?Reason=SIP%3Bcause%3D408>;\
index=1.2.1;rc=1.2
History-Info: <sip:vm@example.com;target=sip:carol%40example.com;\
cause=408>;index=1.2.2;mp=1.2
History-Info: <sip:vm@192.0.2.5;target=sip:carol%40example.com;\
cause=408>;index=1.2.2.1;rc=1.2.2
Contact: Alice <sip:alice@192.0.2.3>
Content-Type: application/sdp
Content-Length: <appropriate value>
```

[SDP Not Shown]

F7 200 OK VM -> example.com

```
SIP/2.0 200 OK
Via: SIP/2.0/TCP proxy.example.com:5060;branch=z9hG4bKbbg4
Via: SIP/2.0/TCP 192.0.2.3:5060;branch=z9hG4bK42t2
From: Alice <sip:alice@example.com>;tag=kkaz-
To: Bob <sip:bob@example.com>;tag=3dweggs
Supported: histinfo
Call-ID: 12345600@example.com
CSeq: 1 INVITE
History-Info: <sip:bob@example.com>;index=1
History-Info: <sip:bob@192.0.2.5?Reason=SIP%3Bcause%3D302\
%3Btext%3D%22Moved%20Temporarily%22>;\
index=1.1;rc=1
History-Info: <sip:carol@example.com>;\
index=1.2;mp=1
History-Info: <sip:carol@192.0.2.4?Reason=SIP%3Bcause%3D408>;\
index=1.2.1;rc=1.2
History-Info: <sip:vm@example.com;target=sip:carol%40example.com;\
cause=408>;index=1.2.2;mp=1.2
History-Info: <sip:vm@192.0.2.5;target=sip:carol%40example.com;\
cause=408>;index=1.2.2.1;rc=1.2.2
Contact: <sip:carol@192.0.2.5>
Content-Type: application/sdp
Content-Length: <appropriate value>
```

[SDP Not Shown]

The VMS can look at the last hi-entry and find the target of the mailbox by looking for the "target" URI parameter in the hi-entry and the reason by the "cause" URI parameter in the same hi-entry.

3.8. GRUU

A variation on the problem in Section 3.5 occurs with Globally Routable User Agent URI (GRUU) [RFC5627]. A GRUU is a URI assigned to a UA instance that has many of the same properties as the AOR but causes requests to be routed only to that specific instance. It is desirable for a UA to know whether it was reached because a correspondent sent a request to its GRUU or to its AOR. This can be used to drive differing authorization policies on whether the request should be accepted or rejected, for example. However, like the AOR itself, the GRUU is lost in translation at the home proxy. Thus, the UAS cannot know whether it was contacted via the GRUU or its AOR.

The following call flow and example messages show how History-Info can be used to find out the GRUU used to reach the callee.

While a GRUU is comprised of an AOR with a URI parameter, as defined in [RFC5627], the GRUU construct itself is not an AOR. Thus, the retargeting of a request based on a GRUU does not result in the addition of an "rc" header field parameter to the hi-entry containing the GRUU. The lack of an "rc" header field parameter in the hi-entries can be a hint that the source of retargeting is a GRUU. However, to ensure this is the case, the UAS needs to search for a "gr" parameter in the hi-entry prior to the last hi-entry. If there is a GRUU, the URI will always be prior to the last hi-entry as the GRUU does not allow multiple instance to be mapped to a contact address.

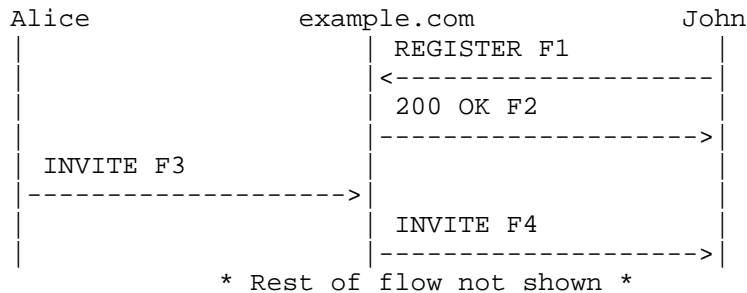

Figure 8: GRUU Example

Message Details

F1 REGISTER John -> example.com

```

REGISTER sip:example.com SIP/2.0
Via: SIP/2.0/UDP 192.0.2.1;branch=z9hG4bKnashds7
Max-Forwards: 70
From: John <sip:John@example.com>;tag=a73kszlfl
Supported: gruu
To: John <sip:john@example.com>
Call-ID: 1j9FpLxk3uxtm8tn@192.0.2.1
CSeq: 1 REGISTER
Contact: <sip:john@192.0.2.1>;+sip.instance=\
  <urn:uuid:f81d4fae-7dec-11d0-a765-00a0c91e6bf6>
Content-Length: 0
  
```

[SDP Not Shown]

F2 200 OK example.com -> John

```
SIP/2.0 200 OK
Via: SIP/2.0/TCP 192.0.2.1;branch=z9hG4bKnashds7
From: John <sip:john@example.com>;tag=a73kszlfl
To: John <sip:john@example.com> ;tag=b88sn
Call-ID: 1j9FpLxk3uxtm8tn@192.0.2.1
CSeq: 1 REGISTER
Contact: <sip:john@192.0.2.1>;\
  pub-gruu="sip:john@example.com;\
  gr=urn:uuid:f81d4fae-7dec-11d0-a765-00a0c91e6bf6";\
  temp-gruu=\
  "sip:tgruu.7hs==jd7vznzga5w7fajsc7-ajd6fabz0f8g5@example.com;\
  gr";+sip.instance=\
  "<urn:uuid:f81d4fae-7dec-11d0-a765-00a0c91e6bf6>";\
  expires=3600
Content-Length: 0
```

[SDP Not Shown]

Assuming Alice has knowledge of a GRUU either through prior communication or through other means such as presence places a call to John's GRUU.

F3 INVITE Alice -> example.com

```
INVITE sip:john@example.com;\
  gr=urn:uuid:f81d4fae-7dec-11d0-a765-00a0c91e6bf6 SIP/2.0
Via: SIP/2.0/TCP 192.0.2.3:5060;branch=z9hG4bK42t2
Max-Forwards: 70
From: Alice <sip:alice@example.com>;tag=kkaz-
To: <sip:john@example.com;\
  gr=urn:uuid:f81d4fae-7dec-11d0-a765-00a0c91e6bf6>
Supported: gruu, histinfo
Call-ID: 12345600@example.com
CSeq: 1 INVITE
History-Info: <sip:john@example.com;\
  gr=urn:uuid:f81d4fae-7dec-11d0-a765-00a0c91e6bf6>;index=1
Contact: Alice <sip:alice@192.0.2.3>
Content-Length: <appropriate value>
```

[SDP Not Shown]

F4 INVITE example.com -> John

```
INVITE sip:john@192.0.2.1 SIP/2.0
Via: SIP/2.0/TCP proxy.example.com:5060;branch=z9hG4bK12s4
Via: SIP/2.0/TCP 192.0.2.3:5060;branch=z9hG4bK42t2
Max-Forwards: 69
From: Alice <sip:alice@example.com>;tag=kkaz-
To: <sip:john@example.com;\
    gr=urn:uuid:f81d4fae-7dec-11d0-a765-00a0c91e6bf6>
Supported: gruu, histinfo
Call-ID: 12345600@example.com
CSeq: 1 INVITE
Record-Route: <sip:proxy.example.com;lr>
History-Info: <sip:john@example.com;\
    gr=urn:uuid:f81d4fae-7dec-11d0-a765-00a0c91e6bf6>;index=1
History-Info: <sip:john@192.0.2.1>;index=1.1;rc=1
Contact: Alice <sip:alice@192.0.2.3>
Content-Type: application/sdp
Content-Length: <appropriate value>
```

[SDP Not Shown]

By analyzing the entry referenced by the entry with the last "rc", one can realize that the URI used to reach the device was GRUU by finding the "gr" parameter.

3.9. Limited-Use Address

A limited-use address is a SIP URI that is minted on-demand, and passed out to a small number (usually one) of remote correspondents. Incoming calls targeted to that limited-use address are accepted as long as the UA still desires communications from the remote target. Should they no longer wish to be bothered by that remote correspondent, the URI is invalidated so that future requests targeted to it are rejected.

Limited-use addresses are used in battling voice spam [RFC5039]. The easiest way to provide them would be for a UA to be able to take its AOR and "mint" a limited-use address by appending additional parameters to the URI. It could then give out the URI to a particular correspondent and remember that URI locally. When an incoming call arrives, the UAS would examine the parameter in the URI and determine whether or not the call should be accepted. Alternatively, the UA could push authorization rules into the network, so that it need not even see incoming requests that are to be rejected.

This approach, especially when executed on the UA, requires that parameters attached to the AOR, but not used by the home proxy in processing the request, survive the translation at the home proxy and be presented to the UA. This will not be the case with the logic in RFC 3261, since the Request-URI is replaced by the registered contact, and any such parameters are lost.

Using the History-Info, John's UA can easily see if the call was addressed to its AOR, GRUU, or a temp-GRUU and treat the call accordingly by looking for a "gr" tag in the hi-entry prior to the last hi-entry.

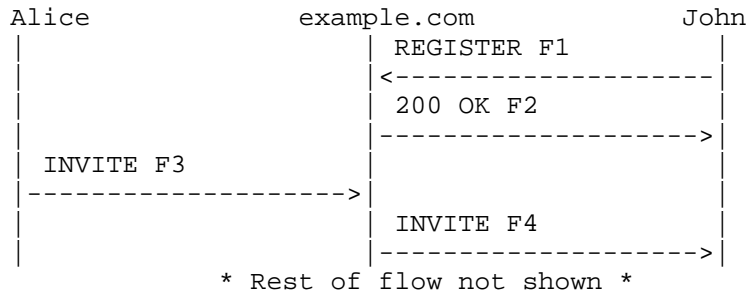

Figure 9: Limited-Use Address Example

Message Details

F1 REGISTER John -> example.com

```

REGISTER sip:example.com SIP/2.0
Via: SIP/2.0/UDP 192.0.2.1;branch=z9hG4bKnashds7
Max-Forwards: 70
From: John <sip:John@example.com>;tag=a73kszlfl
Supported: gruu
To: John <sip:john@example.com>
Call-ID: 1j9FpLxk3uxtm8tn@192.0.2.1
CSeq: 1 REGISTER
Contact: <sip:john@192.0.2.1>;\
  +sip.instance="urn:uuid:f81d4fae-7dec-11d0-a765-00a0c91e6bf6>"
Content-Length: 0
  
```

F2 200 OK example.com -> John

```
SIP/2.0 200 OK
Via: SIP/2.0/UDP 192.0.2.1;branch=z9hG4bKnashds7
From: John <sip:john@example.com>;tag=a73kszlfl
To: John <sip:john@example.com> ;tag=b88sn
Call-ID: 1j9FpLxk3uxtm8tn@192.0.2.1
CSeq: 1 REGISTER
Contact: <sip:john@192.0.2.1>;\
  pub-gruu="sip:john@example.com;\
  gr=urn:uuid:f81d4fae-7dec-11d0-a765-00a0c91e6bf6";\
  temp-gruu=\
  "sip:tgruu.7hs==jd7vnzga5w7fajsc7-ajd6fabz0f8g5@example.com;gr";\
  +sip.instance="<urn:uuid:f81d4fae-7dec-11d0-a765-00a0c91e6bf6>";\
  expires=3600
Content-Length: 0
```

Assuming Alice has knowledge of a temp-GRUU, she places a call to the temp-GRUU.

F3 INVITE Alice -> example.com

```
INVITE sip:tgruu.7hs==jd7vnzga5w7fajsc7-ajd6fabz0f8g5@example.com;\
  gr SIP/2.0
Via: SIP/2.0/UDP 192.0.2.3:5060;branch=z9hG4bK42t2
Max-Forwards: 70
From: Alice <sip:alice@example.com>;tag=kkaz-
To: <sip:tgruu.7hs==jd7vnzga5w7fajsc7-ajd6fabz0f8g5@example.com\
  ;gr>
Supported: gruu, histinfo
Call-ID: 12345600@example.com
CSeq: 1 INVITE
History-Info: \
  <sip:tgruu.7hs==jd7vnzga5w7fajsc7-ajd6fabz0f8g5@example.com;gr>\
  ;index=1
Contact: Alice <sip:alice@192.0.2.3>
Content-Length: <appropriate value>
```

F4 INVITE example.com -> John

```
INVITE sip:john@192.0.2.1 SIP/2.0
Via: SIP/2.0/UDP proxy.example.com:5060;branch=z9hG4bK12s4
Via: SIP/2.0/UDP 192.0.2.3:5060;branch=z9hG4bK42t2
Max-Forwards: 69
From: Alice <sip:alice@example.com>;tag=kkaz-
To: <sip:tgruu.7hs==jd7vnzga5w7fajsc7-ajd6fabz0f8g5@example.com\
;gr>
Supported: gruu, histinfo
Call-ID: 12345600@example.com
CSeq: 1 INVITE
Record-Route: <sip:proxy.example.com;lr>
History-Info: \
  <sip:tgruu.7hs==jd7vnzga5w7fajsc7-ajd6fabz0f8g5@example.com;gr>\
  ;index=1
History-Info: <sip:john@192.0.2.1>;index=1.1;rc=1
Contact: Alice <sip:alice@192.0.2.3>
Content-Type: application/sdp
Content-Length: <appropriate value>
```

By analyzing the entry referenced by the entry with the last "rc", one can realize that the URI used to reach the device was GRUU by finding the "gr" parameter.

3.10. Service Invocation

Several SIP specifications have been developed that make use of complex URIs to address services within the network rather than subscribers. The URIs are complex because they contain numerous parameters that control the behavior of the service. Examples of this include the specification that first introduced the concept, [RFC3087], control of network announcements and Interactive Voice Response (IVR) with SIP URI [RFC4240], and control of voicemail access with SIP URI [RFC4458].

A common problem with all of these mechanisms is that once a proxy has decided to rewrite the Request-URI to point to the service, it cannot be sure that the Request-URI will not be destroyed by a downstream proxy that decides to forward the request in some way, and does so by rewriting the Request-URI.

Section 3.6 shows how History-Info can be used to invoke a service.

3.11. Toll-Free Number

Toll-free numbers, also known in the United States as 800 or 8xx numbers, are telephone numbers that are free for users to call.

In the telephone network, toll-free numbers are just aliases to actual numbers that are used for routing of the call. In order to process the call in the PSTN, a switch will perform a query (using a protocol called Transaction Capabilities Application Part (TCAP)), which will return either a phone number or the identity of a carrier which can handle the call.

There has been recent work on allowing such PSTN translation services to be accessed by SIP proxy servers through IP querying mechanisms. For example, ENUM [RFC6117] has already been proposed as a mechanism for performing Number Portability (NP) queries [RFC4769]. Using it for 8xx number translations is a logical next step.

The new target from translating the 8xx number may be in the PSTN or in the SIP network. If the new target is an entity in the PSTN, the proper treatment in the PSTN (and in particular, correct reconciliation of billing records) requires that the call be marked with both the originating number (8xx number) and the new target number, History-info would come in play here to assure original 8xx number is not lost.

Although not required to have both the originating number (8xx number) and the new target in the SIP network, an enterprise or user who utilize the 8xx service can benefit by knowing whether the call came in via an 8xx number in order to treat the call differently (for example, to play a special announcement), but if the original Request-URI is lost through translation, there is no way to tell if the call came in via 8xx number. History-Info again would come in play here.

Similar problems arise with other "special" numbers and services used in the PSTN, such as operator services, pay/premium numbers (9xx numbers in the United States), and short service codes such as 311.

To find the service number, the UAS can extract the hi-entry whose index matches the value of the first hi-entry with an "mp" tag. Technically, the call can be forwarded to these "special" numbers from non-special numbers; however, that is uncommon based on the way these services authorize translations.

This example call flow shows a UAC that does not support History-Info.

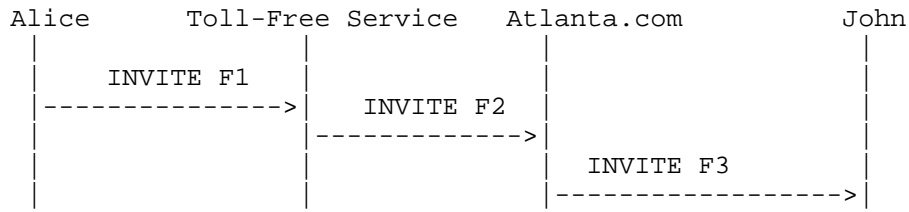

* Rest of flow not shown *

Figure 10: Service Number Example

Message Details

F1 INVITE 192.0.2.1 -> Toll-Free Service

```

INVITE sip:+18005551002@example.com;user=phone SIP/2.0
Via: SIP/2.0/TCP 192.0.2.1:5060;branch=z9hG4bK74bf
From: Alice <sip:+15551001@example.com;user=phone>;tag=9fxced76sl
To: <sip:+18005551002@example.com;user=phone>
Call-ID: c3x842276298220188511
CSeq: 1 INVITE
Max-Forwards: 70
Contact: <sip:alice@192.0.2.1>
Content-Type: application/sdp
Content-Length: <appropriate value>
  
```

[SDP Not Shown]

F2 INVITE Toll-Free Service -> Atlanta.com

```
INVITE sip:+15555551002@atlanta.com SIP/2.0
Via: SIP/2.0/TCP 192.0.2.4:5060;branch=z9hG4bK-ik8
Via: SIP/2.0/TCP 192.0.2.1:5060;branch=z9hG4bK74bf
From: Alice <sip:+15551001@example.com;user=phone>;tag=9fxced76s1
To: <sip:+18005551002@example.com;user=phone>
Call-ID: c3x842276298220188511
CSeq: 1 INVITE
Max-Forwards: 69
Supported: histinfo
History-Info: <sip:+18005551002@example.com;user=phone>;index=1
History-Info: <sip:+15555551002@atlanta.com>;index=1.1;mp=1
Contact: <sip:alice@192.0.2.1>
Content-Type: application/sdp
Content-Length: <appropriate value>
```

[SDP Not Shown]

F3 INVITE Atlanta.com -> John

```
INVITE sip:john@198.51.100.2 SIP/2.0
Via: SIP/2.0/TCP 198.51.100.1:5060;branch=z9hG4bKpxk7g
Via: SIP/2.0/TCP 192.0.2.4:5060;branch=z9hG4bK-ik8
Via: SIP/2.0/TCP 192.0.2.1:5060;branch=z9hG4bK74bf
From: Alice <sip:+15551001@example.com;user=phone>;tag=9fxced76s1
To: <sip:+18005551002@example.com;user=phone>
Call-ID: c3x842276298220188511
CSeq: 1 INVITE
Max-Forwards: 68
Supported: histinfo
History-Info: <sip:+18005551002@example.com;user=phone>;index=1
History-Info: <sip:+15555551002@atlanta.com>;index=1.1;mp=1
History-Info: <sip:john@atlanta.com>;index=1.1.1;rc=1.1
History-Info: <sip:john@198.51.100.2>;index=1.1.1.1;rc=1.1.1
Contact: <sip:alice@192.0.2.1>
Content-Type: application/sdp
Content-Length: <appropriate value>
```

[SDP Not Shown]

4. Security Considerations

The security considerations for the History-Info header field are specified in [RFC7044].

5. Acknowledgements

Jonathan Rosenberg, et al produced the document that provided additional use cases precipitating the requirement for the new "target" parameter in the History-Info header field and the new SIP/SIPS URI parameter. Hadriel Kaplan provided some comments.

Brett Tate, Roland Jesske, Laura Liess, Scott Godin, Dale Worley, and Marianne Mohali provided extensive review and comments on call flows, message examples, and text.

6. Informative References

- [RFC3261] Rosenberg, J., Schulzrinne, H., Camarillo, G., Johnston, A., Peterson, J., Sparks, R., Handley, M., and E. Schooler, "SIP: Session Initiation Protocol", RFC 3261, June 2002.
- [RFC5627] Rosenberg, J., "Obtaining and Using Globally Routable User Agent URIs (GRUUs) in the Session Initiation Protocol (SIP)", RFC 5627, October 2009.
- [RFC3087] Campbell, B. and R. Sparks, "Control of Service Context using SIP Request-URI", RFC 3087, April 2001.
- [RFC4240] Burger, E., Van Dyke, J., and A. Spitzer, "Basic Network Media Services with SIP", RFC 4240, December 2005.
- [RFC5039] Rosenberg, J. and C. Jennings, "The Session Initiation Protocol (SIP) and Spam", RFC 5039, January 2008.
- [RFC4458] Jennings, C., Audet, F., and J. Elwell, "Session Initiation Protocol (SIP) URIs for Applications such as Voicemail and Interactive Voice Response (IVR)", RFC 4458, April 2006.
- [RFC6117] Hoeneisen, B., Mayrhofer, A., and J. Livingood, "IANA Registration of Enumservices: Guide, Template, and IANA Considerations", RFC 6117, March 2011.

- [RFC4769] Livingood, J. and R. Shockey, "IANA Registration for an Enumservice Containing Public Switched Telephone Network (PSTN) Signaling Information", RFC 4769, November 2006.
- [RFC7044] Barnes, M., Audet, F., Schubert, S., van Elburg, J., and C. Holmberg, "An Extension to the Session Initiation Protocol (SIP) for Request History Information", RFC 7044, February 2014.

Authors' Addresses

Mary Barnes
TX
US

E-Mail: mary.ietf.barnes@gmail.com

Francois Audet
Skype

E-Mail: francois.audet@skype.net

Shida Schubert
NTT
Tokyo
Japan

E-Mail: shida@ntt-at.com

Hans Erik van Elburg
Detecon International GmbH
Oberkasseler str. 2
Bonn
Germany

E-Mail: ietf.hanserik@gmail.com

Christer Holmberg
Ericsson
Hirsalantie 11, Jorvas
Finland

E-Mail: christer.holmberg@ericsson.com

