

Transition Scenarios for 3GPP Networks

Status of this Memo

This memo provides information for the Internet community. It does not specify an Internet standard of any kind. Distribution of this memo is unlimited.

Copyright Notice

Copyright (C) The Internet Society (2003). All Rights Reserved.

Abstract

This document describes different scenarios in Third Generation Partnership Project (3GPP) defined packet network, i.e., General Packet Radio Service (GPRS) that would need IP version 6 and IP version 4 transition. The focus of this document is on the scenarios where the User Equipment (UE) connects to nodes in other networks, e.g., in the Internet. GPRS network internal transition scenarios, i.e., between different GPRS elements in the network, are out of scope. The purpose of the document is to list the scenarios for further discussion and study.

Table of Contents

1. Introduction	2
2. Scope of the Document.	2
3. Brief Description of the 3GPP Network Environment.	2
3.1 GPRS Architecture Basics	3
3.2 IP Multimedia Core Network Subsystem (IMS)	3
4. Transition Scenarios	5
4.1 GPRS Scenarios	5
4.2 IMS Scenarios	8
5. Security Considerations.	9
6. Contributing Authors	10
7. Acknowledgements	10
8. References	10
8.1. Normative References	10
8.2. Informative References	11
9. Editor's Address	11
10. Full Copyright Statement	12

1. Introduction

This document describes the transition scenarios in 3GPP packet data networks that might come up in the deployment phase of IPv6. The main purpose of this document is to identify and to document those scenarios for further discussion and study them in the v6ops working group.

Just a brief overview of the 3GPP packet data network, GPRS, is given to help the reader to better understand the transition scenarios. A better overview of the 3GPP specified GPRS can be found for example from [6]. The GPRS architecture is defined in [1].

2. Scope of the Document

The scope is to describe the possible transition scenarios in the 3GPP defined GPRS network where a UE connects to, or is contacted from, the Internet or another UE. The document describes scenarios with and without the usage of the SIP-based (Session Initiation Protocol [5]) IP Multimedia Core Network Subsystem (IMS). The 3GPP releases 1999, 4, and 5 are considered as the basis.

Out of scope are scenarios inside the GPRS network, i.e., on the different interfaces of the GPRS network. This document neither changes 3GPP specifications, nor proposes changes to the current specifications.

In addition, the possible transition scenarios are described. The solutions will be documented in a separate document.

All the possible scenarios are listed here. Further analysis may show that some of the scenarios are not actually relevant in this context.

3. Brief Description of the 3GPP Network Environment

This section describes the most important concepts of the 3GPP environment for understanding the transition scenarios. The first part of the description gives a brief overview to the GPRS network as such. The second part concentrates on the IP Multimedia Core Network Subsystem (IMS).

3.1. GPRS Architecture Basics

This section gives an overview to the most important concepts of the 3GPP packet architecture. For more detailed description, please see [1].

From the point of view of this document, the most relevant 3GPP architectural elements are the User Equipment (UE), and the Gateway GPRS Support Node (GGSN). A simplified picture of the architecture is shown in Figure 1.

The UE is the mobile phone. It can either be an integrated device comprising a combined GPRS part, and the IP stack, or it might be a separate GPRS device, and separate equipment with the IP stack, e.g., a laptop.

The GGSN serves as an anchor-point for the GPRS mobility management. It also serves as the default router for the UE.

The Peer node mentioned in the picture refers to a node with which the UE is communicating.

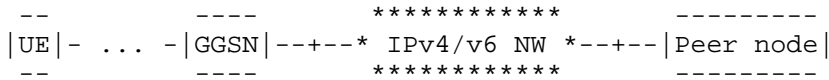

Figure 1: Simplified GPRS Architecture

There is a dedicated link between the UE and the GGSN called the Packet Data Protocol (PDP) Context. This link is created through the PDP Context activation process. During the activation the UE is configured with its IP address and other information needed to maintain IP access, e.g., DNS server address. There are three different types of PDP Contexts: IPv4, IPv6, and Point-to-Point Protocol (PPP).

A UE can have one or more simultaneous PDP Contexts open to the same or to different GGSNs. The PDP Context can be either of the same or different types.

3.2. IP Multimedia Core Network Subsystem (IMS)

IP Multimedia Core Network Subsystem (IMS) is an architecture for supporting multimedia services via a SIP infrastructure. It is specified in 3GPP Release 5. This section provides an overview of the 3GPP IMS and is not intended to be comprehensive. A more detailed description can be found in [2], [3] and [4].

The IMS comprises a set of SIP proxies, servers, and registrars. In addition, there are Media Gateways (MGWs) that offer connections to non-IP networks such as the Public Switched Telephony Network (PSTN). A simplified overview of the IMS is depicted in figure 2.

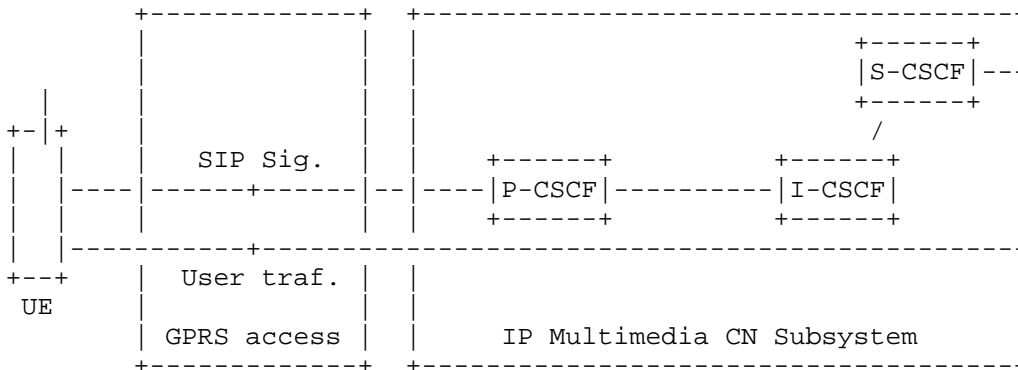

Figure 2: Overview of the 3GPP IMS architecture

The SIP proxies, servers, and registrars shown in Figure 2 are as follows.

- P-CSCF (Proxy-Call Session Control Function) is the first contact point within the IMS for the subscriber.
- I-CSCF (Interrogating-CSCF) is the contact point within an operator's network for all connections destined to a subscriber of that network operator, or a roaming subscriber currently located within that network operator's service area.
- S-CSCF (Serving-CSCF) performs the session control services for the subscriber. It also acts as a SIP Registrar.

IMS capable UEs utilize the GPRS network as an access network for accessing the IMS. Thus, a UE has to have an activated PDP Context to the IMS before it can proceed to use the IMS services. The PDP Context activation is explained briefly in section 3.1.

The IMS is exclusively IPv6. Thus, the activated PDP Context is of PDP Type IPv6. This means that a 3GPP IP Multimedia terminal uses exclusively IPv6 to access the IMS, and the IMS SIP server and proxy support exclusively IPv6. Hence, all the traffic going to the IMS is IPv6, even if the UE is dual stack capable - this comprises both signaling and user traffic.

This, of course, does not prevent the usage of other unrelated services (e.g., corporate access) on IPv4.

4. Transition Scenarios

This section is divided into two main parts - GPRS scenarios, and scenarios with the IP Multimedia Subsystem (IMS). The first part - GPRS scenarios - concentrates on scenarios with a User Equipment (UE) connecting to services in the Internet, e.g., mail, web. The second part - IMS scenarios - then describes how an IMS capable UE can connect to other SIP-capable nodes in the Internet using the IMS services.

4.1. GPRS Scenarios

This section describes the scenarios that might occur when a GPRS UE contacts services, or nodes outside the GPRS network, e.g., web-server in the Internet.

Transition scenarios of the GPRS internal interfaces are outside of the scope of this document.

The following scenarios are described here. In all of the scenarios, the UE is part of a network where there is at least one router of the same IP version, i.e., GGSN, and it is connecting to a node in a different network.

The scenarios here apply also for PDP Context type Point-to-Point Protocol (PPP) where PPP is terminated at the GGSN. On the other hand, where the PPP PDP Context is terminated e.g., at an external ISP, the environment is the same as for general ISP cases.

- 1) Dual Stack UE connecting to IPv4 and IPv6 nodes
- 2) IPv6 UE connecting to an IPv6 node through an IPv4 network
- 3) IPv4 UE connecting to an IPv4 node through an IPv6 network
- 4) IPv6 UE connecting to an IPv4 node
- 5) IPv4 UE connecting to an IPv6 node

- 1) Dual Stack UE connecting to IPv4 and IPv6 nodes

The GPRS system has been designed in a manner that there is the possibility to have simultaneous IPv4, and IPv6 PDP Contexts open. Thus, in cases where the UE is dual stack capable, and in the network there is a GGSN (or separate GGSNs) that supports both connections to IPv4 and IPv6 networks, it is possible to connect to both at the same time. Figure 3 depicts this scenario.

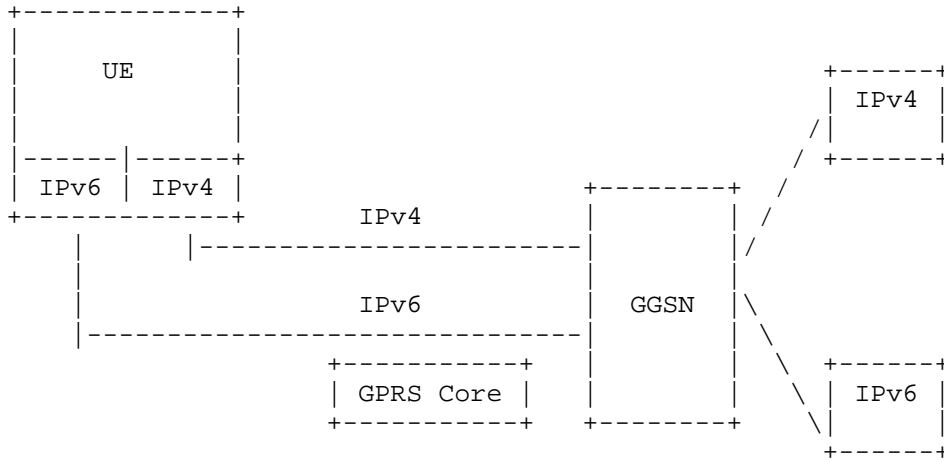

Figure 3: Dual-Stack Case

However, the IPv4 addresses may be a scarce resource for the mobile operator or an ISP. In that case, it might not be possible for the UE to have a globally unique IPv4 address allocated all the time. Hence, the UE could either activate the IPv4 PDP Context only when needed, or be allocated an IPv4 address from a private address space.

2) IPv6 UE connecting to an IPv6 node through an IPv4 network

Especially in the initial stages of IPv6 deployment, there are cases where an IPv6 node would need to connect to the IPv6 Internet through a network that is IPv4. For instance, this can be seen in current fixed networks, where the access is provided via IPv4 only, but there is an IPv6 network deeper in the Internet. This scenario is shown in Figure 4.

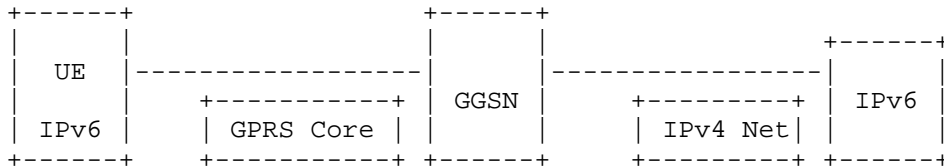

Figure 4: IPv6 nodes communicating over IPv4

In this case, in the GPRS system, the UE would be IPv6 capable, and the GPRS network would provide an IPv6 capable GGSN in the network. However, there is an IPv4 network between the GGSN, and the peer node.

3) IPv4 UE connecting to an IPv4 node through an IPv6 network

Further in the future, there are cases where the legacy UEs are still IPv4 only, capable of connecting only to the legacy IPv4 Internet. However, the GPRS operator network has already been upgraded to IPv6. Figure 5 represents this scenario.

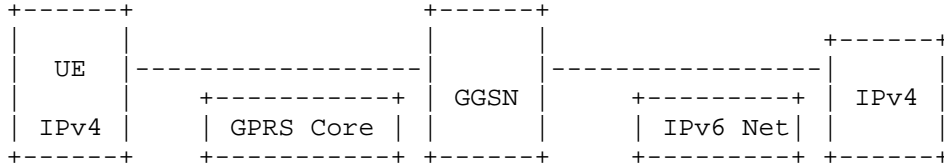

Figure 5: IPv4 nodes communicating over IPv6

In this case, the operator would still provide an IPv4 capable GGSN, and a connection through the IPv6 network to the IPv4 Internet.

4) IPv6 UE connecting to an IPv4 node

In this scenario, an IPv6 UE connects to an IPv4 node in the IPv4 Internet. As an example, an IPv6 UE connects to an IPv4 web server in the legacy Internet. In the figure 6, this kind of possible installation is described.

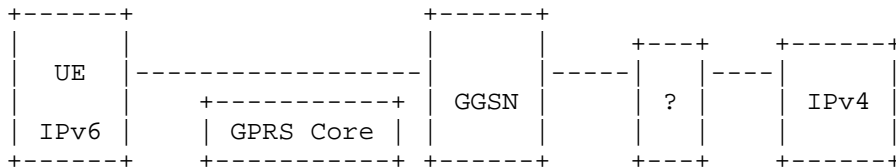

Figure 6: IPv6 node communicating with IPv4 node

5) IPv4 UE connecting to an IPv6 node

This is similar to the case above, but in the opposite direction. Here an IPv4 UE connects to an IPv6 node in the IPv6 Internet. As an example, a legacy IPv4 UE is connected to an IPv6 server in the IPv6 Internet. Figure 7 depicts this configuration.

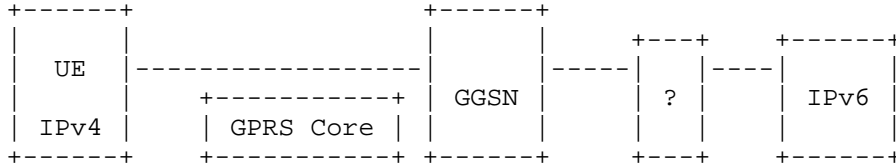

Figure 7: IPv4 node communicating with IPv6 node

4.2. IMS Scenarios

As described in section 3.2, IMS is exclusively IPv6. Thus, the number of possible transition scenarios is reduced dramatically. In the following, the possible transition scenarios are listed.

- 1) UE connecting to a node in an IPv4 network through IMS
- 2) Two IPv6 IMS connected via an IPv4 network

1) UE connecting to a node in an IPv4 network through IMS

This scenario occurs when an IMS UE (IPv6) connects to a node in the IPv4 Internet through the IMS, or vice versa. This happens when the other node is a part of a different system than 3GPP, e.g., a fixed PC, with only IPv4 capabilities. This scenario is shown in the Figure 8.

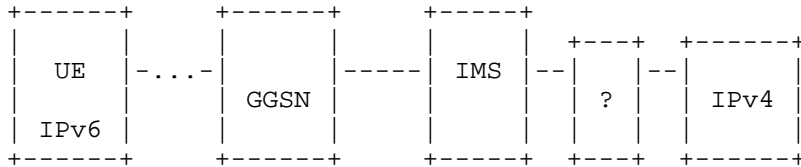

Figure 8: IMS UE connecting to an IPv4 node

2) Two IPv6 IMS connected via an IPv4 network

At the early stages of IMS deployment, there may be cases where two IMS islands are only connected via an IPv4 network such as the legacy Internet. See Figure 9 for illustration.

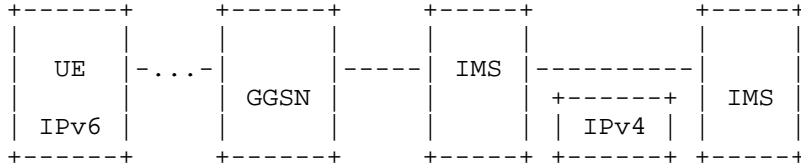

Figure 9: Two IMS islands connected over IPv4

5. Security Considerations

This document describes possible transition scenarios for 3GPP networks for future study. Solutions and mechanism are explored in other documents. The description of the 3GPP network scenarios does not have any security issues.

6. Contributing Authors

This document is a result of a joint effort of a design team. The members of the design team are listed in the following.

Alain Durand, Sun Microsystems
<Alain.Durand@sun.com>

Karim El-Malki, Ericsson Radio Systems
<Karim.El-Malki@era.ericsson.se>

Niall Richard Murphy, Enigma Consulting Limited
<niallm@enigma.ie>

Hugh Shieh, AT&T Wireless
<hugh.shieh@attws.com>

Jonne Soininen, Nokia
<jonne.soininen@nokia.com>

Hesham Soliman, Ericsson Radio Systems
<hesham.soliman@era.ericsson.se>

Margaret Wasserman, Wind River
<mrw@windriver.com>

Juha Wiljakka, Nokia
<juha.wiljakka@nokia.com>

7. Acknowledgements

The authors would like to thank Basavaraj Patil, Tuomo Sipila, Fred Templin, Rod Van Meter, Pekka Savola, Francis Dupont, Christine Fisher, Alain Baudot, Rod Walsh, and Jens Staack for good input, and comments that helped writing this document.

8. References

8.1. Normative References

- [1] 3GPP TS 23.060 v 5.2.0, "General Packet Radio Service (GPRS); Service description; Stage 2(Release 5)", June 2002.
- [2] 3GPP TS 23.228 v 5.3.0, "IP Multimedia Subsystem (IMS); Stage 2(Release 5)", January 2002.

- [3] 3GPP TS 24.228 V5.0.0, "Signalling flows for the IP multimedia call control based on SIP and SDP; Stage 3 (Release 5)", March 2002.
- [4] 3GPP TS 24.229 V5.0.0, "IP Multimedia Call Control Protocol based on SIP and SDP; Stage 3 (Release 5)", March 2002.
- [5] Rosenberg, J., Schulzrinne, H., Camarillo, G., Johnston, A., Peterson, J., Sparks, R., Handley, M. and E. Schooler, "SIP: Session Initiation Protocol", RFC 3261, June 2002.

8.2. Informative References

- [6] Wasserman, M., "Recommendations for IPv6 in Third Generation Partnership Project (3GPP) Standards", RFC 3314, September 2002.

9. Editor's Address

Jonne Soininen
Nokia
313 Fairchild Dr.
Mountain View, CA, USA

Phone: +1-650-864-6794
EMail: jonne.soininen@nokia.com

10. Full Copyright Statement

Copyright (C) The Internet Society (2003). All Rights Reserved.

This document and translations of it may be copied and furnished to others, and derivative works that comment on or otherwise explain it or assist in its implementation may be prepared, copied, published and distributed, in whole or in part, without restriction of any kind, provided that the above copyright notice and this paragraph are included on all such copies and derivative works. However, this document itself may not be modified in any way, such as by removing the copyright notice or references to the Internet Society or other Internet organizations, except as needed for the purpose of developing Internet standards in which case the procedures for copyrights defined in the Internet Standards process must be followed, or as required to translate it into languages other than English.

The limited permissions granted above are perpetual and will not be revoked by the Internet Society or its successors or assignees.

This document and the information contained herein is provided on an "AS IS" basis and THE INTERNET SOCIETY AND THE INTERNET ENGINEERING TASK FORCE DISCLAIMS ALL WARRANTIES, EXPRESS OR IMPLIED, INCLUDING BUT NOT LIMITED TO ANY WARRANTY THAT THE USE OF THE INFORMATION HEREIN WILL NOT INFRINGE ANY RIGHTS OR ANY IMPLIED WARRANTIES OF MERCHANTABILITY OR FITNESS FOR A PARTICULAR PURPOSE.

Acknowledgement

Funding for the RFC Editor function is currently provided by the Internet Society.

