

Internet Engineering Task Force (IETF)  
Request for Comments: 7326  
Category: Informational  
ISSN: 2070-1721

J. Parello  
B. Claise  
Cisco Systems, Inc.  
B. Schoening  
Independent Consultant  
J. Quittek  
NEC Europe Ltd.  
September 2014

## Energy Management Framework

### Abstract

This document defines a framework for Energy Management (EMAN) for devices and device components within, or connected to, communication networks. The framework presents a physical reference model and information model. The information model consists of an Energy Management Domain as a set of Energy Objects. Each Energy Object can be attributed with identity, classification, and context. Energy Objects can be monitored and controlled with respect to power, Power State, energy, demand, Power Attributes, and battery. Additionally, the framework models relationships and capabilities between Energy Objects.

### Status of This Memo

This document is not an Internet Standards Track specification; it is published for informational purposes.

This document is a product of the Internet Engineering Task Force (IETF). It represents the consensus of the IETF community. It has received public review and has been approved for publication by the Internet Engineering Steering Group (IESG). Not all documents approved by the IESG are a candidate for any level of Internet Standard; see Section 2 of RFC 5741.

Information about the current status of this document, any errata, and how to provide feedback on it may be obtained at <http://www.rfc-editor.org/info/rfc7326>.

## Copyright Notice

Copyright (c) 2014 IETF Trust and the persons identified as the document authors. All rights reserved.

This document is subject to BCP 78 and the IETF Trust's Legal Provisions Relating to IETF Documents (<http://trustee.ietf.org/license-info>) in effect on the date of publication of this document. Please review these documents carefully, as they describe your rights and restrictions with respect to this document. Code Components extracted from this document must include Simplified BSD License text as described in Section 4.e of the Trust Legal Provisions and are provided without warranty as described in the Simplified BSD License.

## Table of Contents

1. Introduction .....	3
2. Terminology .....	4
3. Target Devices .....	9
4. Physical Reference Model .....	10
5. Areas Not Covered by the Framework .....	11
6. Energy Management Abstraction .....	12
6.1. Conceptual Model .....	12
6.2. Energy Object (Class) .....	13
6.3. Energy Object Attributes .....	15
6.4. Measurements .....	18
6.5. Control .....	19
6.6. Relationships .....	25
7. Energy Management Information Model .....	29
8. Modeling Relationships between Devices .....	33
8.1. Power Source Relationship .....	33
8.2. Metering Relationship .....	37
8.3. Aggregation Relationship .....	38
9. Relationship to Other Standards .....	39
10. Security Considerations .....	39
10.1. Security Considerations for SNMP .....	40
11. IANA Considerations .....	41
11.1. IANA Registration of New Power State Sets .....	41
11.2. Updating the Registration of Existing Power State Sets .....	42
12. References .....	43
12.1. Normative References .....	43
12.2. Informative References .....	44
13. Acknowledgments .....	45
Appendix A. Information Model Listing .....	46

## 1. Introduction

Network Management is often divided into the five main areas defined in the ISO Telecommunications Management Network model: Fault, Configuration, Accounting, Performance, and Security Management (FCAPS) [X.700]. Not covered by this traditional management model is Energy Management, which is rapidly becoming a critical area of concern worldwide, as seen in [ISO50001].

This document defines an Energy Management framework for devices within, or connected to, communication networks, per the Energy Management requirements specified in [RFC6988]. The devices, or the components of these devices (such as line cards, fans, and disks), can then be monitored and controlled. Monitoring includes measuring power, energy, demand, and attributes of power. Energy Control can be performed by setting a device's or component's state. The devices monitored by this framework can be either of the following:

- o consumers of energy (such as routers and computer systems) and components of such devices (such as line cards, fans, and disks)
- o producers of energy (like an uninterruptible power supply or renewable energy system) and their associated components (such as battery cells, inverters, or photovoltaic panels)

This framework further describes how to identify, classify, and provide context for such devices. While context information is not specific to Energy Management, some context attributes are specified in the framework, addressing the following use cases:

- o How important is a device in terms of its business impact?
- o How should devices be grouped for reporting and searching?
- o How should a device role be described?

Guidelines for using context for Energy Management are described.

The framework introduces the concept of a Power Interface that is analogous to a network interface. A Power Interface is defined as an interconnection among devices where energy can be provided, received, or both.

The most basic example of Energy Management is a single device reporting information about itself. In many cases, however, energy is not measured by the device itself but is measured upstream in the power distribution tree. For example, a Power Distribution Unit (PDU) may measure the energy it supplies to attached devices and

report this to an Energy Management System. Therefore, devices often have relationships to other devices or components in the power network. An Energy Management System (EnMS) generally requires an understanding of the power topology (who provides power to whom), the Metering topology (who meters whom), and the potential Aggregation (who aggregates values of others).

The relationships build on the Power Interface concept. The different relationships among devices and components, as specified in this document, include power source, Metering, and Aggregation Relationships.

The framework does not cover non-electrical equipment, nor does it cover energy procurement and manufacturing.

## 2. Terminology

The key words "MUST", "MUST NOT", "REQUIRED", "SHALL", "SHALL NOT", "SHOULD", "SHOULD NOT", "RECOMMENDED", "MAY", and "OPTIONAL" in this document are to be interpreted as described in RFC 2119 [RFC2119].

In this document, these words will appear with the above interpretation only when in ALL CAPS. Lowercase uses of these words are not to be interpreted as carrying the significance of RFC 2119 key words.

In this section, some terms have a NOTE that is not part of the definition itself but accounts for differences between terminologies of different standards organizations or further clarifies the definition.

The terms are listed in an order that aids in reading where terms may build off a previous term, as opposed to an alphabetical ordering. Some terms that are common in electrical engineering or that describe common physical items use a lowercase notation.

### Energy Management

Energy Management is a set of functions for measuring, modeling, planning, and optimizing networks to ensure that the network and network-attached devices use energy efficiently and appropriately for the nature of the application and the cost constraints of the organization.

Reference: Adapted from [TMN].

## NOTES:

1. "Energy Management" refers to the activities, methods, procedures, and tools that pertain to measuring, modeling, planning, controlling, and optimizing the use of energy in networked systems [NMF].
2. Energy Management is a management domain that is congruent to any of the FCAPS areas of management in the ISO/OSI Network Management Model [TMN]. Energy Management for communication networks and attached devices is a subset or part of an organization's greater Energy Management Policies.

## Energy Management System (EnMS)

An Energy Management System is a combination of hardware and software used to administer a network, with the primary purpose of Energy Management.

## NOTES:

1. An Energy Management System according to [ISO50001] (ISO-EnMS) is a set of systems or procedures upon which organizations can develop and implement an energy policy, set targets and action plans, and take into account legal requirements related to energy use. An ISO-EnMS allows organizations to improve energy performance and demonstrate conformity to requirements, standards, and/or legal requirements.
2. Example ISO-EnMS: Company A defines a set of policies and procedures indicating that there should exist multiple computerized systems that will poll energy measurements from their meters and pricing / source data from their local utility. Company A specifies that their CFO (Chief Financial Officer) should collect information and summarize it quarterly to be sent to an accounting firm to produce carbon accounting reporting as required by their local government.
3. For the purposes of EMAN, the definition herein is the preferred meaning of an EnMS. The definition from [ISO50001] can be referred to as an ISO Energy Management System (ISO-EnMS).

## Energy Monitoring

Energy Monitoring is a part of Energy Management that deals with collecting or reading information from devices to aid in Energy Management.

**Energy Control**

Energy Control is a part of Energy Management that deals with directing influence over devices.

**electrical equipment**

This is a general term that includes materials, fittings, devices, appliances, fixtures, apparatus, machines, etc., that are used as a part of, or in connection with, an electric installation.

Reference: [IEEE100].

**non-electrical equipment (mechanical equipment)**

This is a general term that includes materials, fittings, devices, appliances, fixtures, apparatus, machines, etc., that are used as a part of, or in connection with, non-electrical power installations.

Reference: Adapted from [IEEE100].

**device**

A device is a piece of electrical or non-electrical equipment.

Reference: Adapted from [IEEE100].

**component**

A component is a part of electrical or non-electrical equipment (device).

Reference: Adapted from [TMN].

**power inlet**

A power inlet (or simply "inlet") is an interface at which a device or component receives energy from another device or component.

**power outlet**

A power outlet (or simply "outlet") is an interface at which a device or component provides energy to another device or component.

**energy**

Energy is that which does work or is capable of doing work. As used by electric utilities, it is generally a reference to electrical energy and is measured in kilowatt-hours (kWh).

Reference: [IEEE100].

## NOTE:

1. Energy is the capacity of a system to produce external activity or perform work [ISO50001].

## power

Power is the time rate at which energy is emitted, transferred, or received; power is usually expressed in watts (joules per second).

Reference: [IEEE100].

## demand

Demand is the average value of power or a related quantity over a specified interval of time. Note: Demand is expressed in kilowatts, kilovolt-amperes, kilovars, or other suitable units.

Reference: [IEEE100].

## NOTE:

1. While IEEE100 defines demand in kilo measurements, for EMAN we use watts with any suitable metric prefix.

## provide energy

A device (or component) "provides" energy to another device if there is an energy flow from this device to the other one.

## receive energy

A device (or component) "receives" energy from another device if there is an energy flow from the other device to this one.

## meter (energy meter)

A meter is a device intended to measure electrical energy by integrating power with respect to time.

Reference: Adapted from [IEC60050].

## battery

A battery is one or more cells (consisting of an assembly of electrodes, electrolyte, container, terminals, and (usually) separators) that are a source and/or store of electric energy.

Reference: Adapted from [IEC60050].

## Power Interface

A Power Interface is a power inlet, outlet, or both.

#### Nameplate Power

The Nameplate Power is the nominal power of a device as specified by the device manufacturer.

#### Power Attributes

Power Attributes are measurements of the electrical current, voltage, phase, and frequencies at a given point in an electrical power system.

Reference: Adapted from [IEC60050].

#### NOTE:

1. Power Attributes are not intended to provide any bounds or recommended range for the value. They are simply the reading of the value associated with the attribute in question.

#### Power Quality

"Power Quality" refers to characteristics of the electrical current, voltage, phase, and frequencies at a given point in an electric power system, evaluated against a set of reference technical parameters. These parameters might, in some cases, relate to the compatibility between electricity supplied in an electric power system and the loads connected to that electric power system.

Reference: [IEC60050].

#### NOTE:

1. Electrical characteristics representing Power Quality information are typically required by customer facility Energy Management Systems. Electrical characteristics are not intended to satisfy the detailed requirements of Power Quality monitoring. Standards typically also give ranges of allowed values; the information attributes are the raw measurements, not the "yes/no" determination by the various standards.

Reference: [ASHRAE-201].



#### Power State

A Power State is a condition or mode of a device (or component) that broadly characterizes its capabilities, power, and responsiveness to input.

Reference: Adapted from [IEEE1621].

#### Power State Set

A Power State Set is a collection of Power States that comprises a named or logical control grouping.

### 3. Target Devices

With Energy Management, there exists a wide variety of devices that may be contained in the same deployment as a communication network but comprise a separate facility, home, or power distribution network.

Energy Management has special challenges because a power distribution network supplies energy to devices and components, while a separate communications network monitors and controls the power distribution network.

The target devices for Energy Management are all devices that can be monitored or controlled (directly or indirectly) by an Energy Management System (EnMS). These target devices include, for example:

- o Simple electrical appliances and fixtures
- o Hosts, such as a PC, a server, or a printer
- o Switches, routers, base stations, and other network equipment such as middleboxes
- o Components within devices, e.g., a line card inside a switch
- o Batteries functioning as a device or component that is a store of energy
- o Devices or components that charge or produce energy, such as solar cells, charging stations, or generators
- o Power over Ethernet (PoE) endpoints
- o Power Distribution Units (PDUs)
- o Protocol gateway devices for Building Management Systems (BMS)

- o Electrical meters
- o Sensor controllers with subtended sensors

Target devices include devices that communicate via the Internet Protocol (IP) as well as devices using other means for communication. The latter are managed through gateways or proxies that can communicate using IP.

#### 4. Physical Reference Model

The following reference model describes physical power topologies that exist in parallel with a communication topology. While many more topologies can be created with a combination of devices, the following are some basic ones that show how Energy Management topologies differ from Network Management topologies.

NOTE: "###" is used to denote a transfer of energy.  
 "- >" is used to denote a transfer of information.

##### Basic Energy Management:

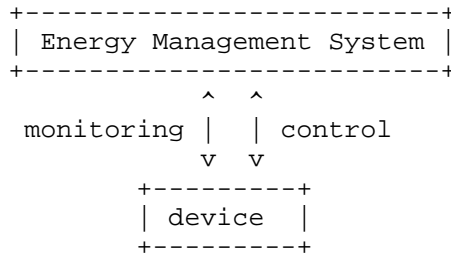

##### Basic Power Supply:

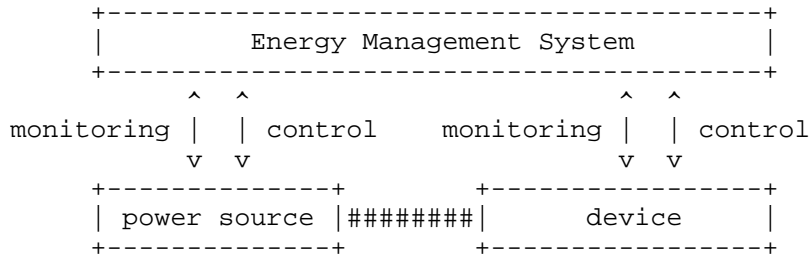

Single Power Supply with Multiple Devices:

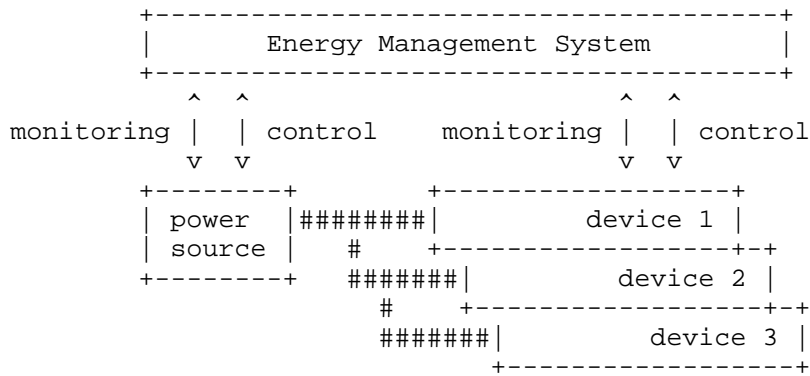

Multiple Power Supplies with Single Device:

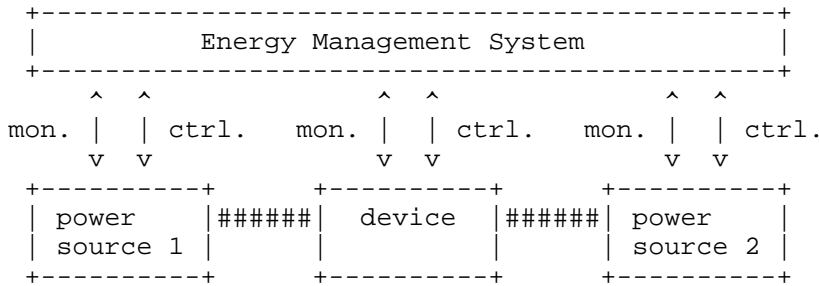

5. Areas Not Covered by the Framework

While this framework is intended as a framework for Energy Management in general, there are some areas that are not covered.

Non-Electrical Equipment

The primary focus of this framework is the management of electrical equipment. Non-electrical equipment, which is not covered in this framework, could nevertheless be modeled by providing interfaces that comply with the framework: for example, using the same units for power and energy. Therefore, non-electrical equipment that does not "convert to" or "present as" an entity equivalent to electrical equipment is not addressed.

## Energy Procurement and Manufacturing

While an EnMS may be a central point for corporate reporting, cost computation, environmental impact analysis, and regulatory compliance reporting, Energy Management in this framework excludes energy procurement and the environmental impact of energy use.

As such, the framework does not include:

- o Cost in currency or environmental units of manufacturing a device
- o Embedded carbon or environmental equivalences of a device
- o Cost in currency or environmental impact to dismantle or recycle a device
- o Supply chain analysis of energy sources for device deployment
- o Conversion of the usage or production of energy to units expressed from the source of that energy (such as the greenhouse gas emissions associated with the transfer of energy from a diesel source)

## 6. Energy Management Abstraction

This section describes a conceptual model of information that can be used for Energy Management. The classes and categories of attributes in the model are described, with a rationale for each.

### 6.1. Conceptual Model

This section describes an information model that addresses issues specific to Energy Management and complements existing Network Management models.

An information model for Energy Management will need to describe a means to monitor and control devices and components. The model will also need to describe the relationships among, and connections between, devices and components.

This section defines a conceptual model for devices and components that is similar to the model used in Network Management: devices, components, and interfaces. This section then defines the additional attributes specific to Energy Management for those entities that are not available in existing Network Management models.

For modeling the devices and components, this section describes three classes denoted by a "(Class)" suffix: a Device (Class), a Component (Class), and a Power Interface (Class). These classes are sub-types of an abstract Energy Object (Class).

#### Summary of Notation for Modeling Physical Equipment

Physical	Modeling (Metadata)	Model Instance
-----		
equipment	Energy Object (Class)	Energy Object
device	Device (Class)	Device
component	Component (Class)	Component
inlet/outlet	Power Interface (Class)	Power Interface

This section then describes the attributes of an Energy Object (Class) for identification, classification, context, control, power, and energy.

Since the interconnections between devices and components for Energy Management may have no relation to the interconnections for Network Management, the Energy Object (Classes) contain a separate Relationships (Class) as an attribute to model these types of interconnections.

The next sections describe each of the classes and categories of attributes in the information model.

Not all of the attributes are mandatory for implementations. Specifications describing implementations of the information model in this framework need to be explicit about which are mandatory and which are optional to implement.

The formal definitions of the classes and attributes are specified in Section 7.

## 6.2. Energy Object (Class)

An Energy Object (Class) represents a piece of equipment that is part of, or attached to, a communications network that is monitored or controlled or that aids in the management of another device for Energy Management.

The Energy Object (Class) is an abstract class that contains the base attributes to represent a piece of equipment for Energy Management. There are three types of Energy Object (Class): Device (Class), Component (Class), and Power Interface (Class).

#### 6.2.1. Device (Class)

The Device (Class) is a subclass of Energy Object (Class) that represents a physical piece of equipment.

A Device (Class) instance represents a device that is a consumer, producer, meter, distributor, or store of energy.

A Device (Class) instance may represent a physical device that contains other components.

#### 6.2.2. Component (Class)

The Component (Class) is a subclass of Energy Object (Class) that represents a part of a physical piece of equipment.

#### 6.2.3. Power Interface (Class)

A Power Interface (Class) represents the interconnections (inlet, outlet) among devices or components where energy can be provided, received, or both.

The Power Interface (Class) is a subclass of Energy Object (Class) that represents a physical inlet or outlet.

There are some similarities between Power Interfaces and network interfaces. A network interface can be set to different states, such as sending or receiving data on an attached line. Similarly, a Power Interface can be receiving or providing energy.

A Power Interface (Class) instance can represent (physically) an AC power socket, an AC power cord attached to a device, or an 8P8C (RJ45) PoE socket, etc.

### 6.3. Energy Object Attributes

This section describes categories of attributes for an Energy Object (Class).

#### 6.3.1. Identification

A Universally Unique Identifier (UUID) [RFC4122] is used to uniquely and persistently identify an Energy Object.

Every Energy Object has an optional unique human-readable printable name. Possible naming conventions are textual DNS name, Media Access Control (MAC) address of the device, interface `ifName`, or a text string uniquely identifying the Energy Object. As an example, in the case of IP phones, the Energy Object name can be the device's DNS name.

Additionally, an alternate key is provided to allow an Energy Object to be optionally linked with models in different systems.

#### 6.3.2. Context: General

In order to aid in reporting and in differentiation between Energy Objects, each object optionally contains information establishing its business, site, or organizational context within a deployment.

The Energy Object (Class) contains a category attribute that broadly describes how an instance is used in a deployment. The category indicates whether the Energy Object is primarily functioning as a consumer, producer, meter, distributor, or store of energy.

Given the category and context of an object, an EnMS can summarize or analyze measurements for the site.

#### 6.3.3. Context: Importance

An Energy Object can provide an importance value in the range of 1 to 100 to help rank a device's use or relative value to the site. The importance range is from 1 (least important) to 100 (most important). The default importance value is 1.

For example, a typical office environment has several types of phones, which can be rated according to their business impact. A public desk phone has a lower importance (for example, 10) than a business-critical emergency phone (for example, 100). As another example, a company can consider that a PC and a phone for a customer service engineer are more important than a PC and a phone for lobby use.

Although EnMS and administrators can establish their own ranking, the following example is a broad recommendation for commercial deployments [CISCO-EW]:

90 to 100	Emergency response
80 to 90	Executive or business-critical
70 to 79	General or average
60 to 69	Staff or support
40 to 59	Public or guest
1 to 39	Decorative or hospitality

#### 6.3.4. Context: Keywords

The Energy Object (Class) contains an attribute with context keywords.

An Energy Object can provide a set of keywords that is a list of tags that can be used for grouping, summary reporting (within or between Energy Management Domains), and searching. Potential examples are IT, lobby, HumanResources, Accounting, StoreRoom, CustomerSpace, router, phone, floor2, or SoftwareLab.

The specifics of how this tag is represented are left to the MIB module or other object definition documents to be based on this framework.

There is no default value for a keyword. Multiple keywords can be assigned to an Energy Object.

#### 6.3.5. Context: Role

The Energy Object (Class) contains a role attribute. The "role description" string indicates the primary purpose the Energy Object serves in the deployment. This could be a string representing the purpose the Energy Object fulfills in the deployment.

The specifics of how this tag is represented are left to the MIB module or other object definition documents to be based on this framework.

Administrators can define any naming scheme for the role. As guidance, a two-word role that combines the service the Energy Object provides, along with type, can be used [IPENERGY].

Example types of devices: Router, Switch, Light, Phone, WorkStation, Server, Display, Kiosk, HVAC.



## Example Services by Line of Business:

Line of Business	Service
Education	Student, Faculty, Administration, Athletic
Finance	Trader, Teller, Fulfillment
Manufacturing	Assembly, Control, Shipping
Retail	Advertising, Cashier
Support	Helpdesk, Management
Medical	Patient, Administration, Billing

Role as a two-word string: "Faculty Desktop", "Teller Phone", "Shipping HVAC", "Advertising Display", "Helpdesk Kiosk", "Administration Switch".

The specifics of how this tag is represented are left to the MIB module or other object definition documents to be based on this framework.

## 6.3.6. Context: Domain

The Energy Object (Class) contains a string attribute to indicate membership in an Energy Management Domain. An Energy Management Domain can be any collection of Energy Objects in a deployment, but it is recommended to map 1:1 with a metered or sub-metered portion of the site.

In building management, a meter refers to the meter provided by the utility used for billing and measuring power to an entire building or unit within a building. A sub-meter refers to a customer- or user-installed meter that is not used by the utility to bill but is instead used to get measurements from portions of a building.

The specifics of how this tag is represented are left to the MIB module or other object definition documents to be based on this framework.

An Energy Object MUST be a member of a single Energy Management Domain; therefore, one attribute is provided.

#### 6.4. Measurements

The Energy Object (Class) contains attributes to describe power, energy, and demand measurements.

An analogy for understanding power versus energy measurements can be made to speed and distance in automobiles. Just as a speedometer indicates the rate of change of distance (speed), a power measurement indicates the rate of transfer of energy. The odometer in an automobile measures the cumulative distance traveled; similarly, an energy measurement indicates the accumulated energy transferred.

Demand measurements are averages of power measurements over time. So, using the same analogy to an automobile: measuring the average vehicle speed over multiple intervals of time for a given distance traveled, demand is the average power measured over multiple time intervals for a given energy value.

Within this framework, energy will only be quantified in units of watt-hours. Physical devices measuring energy in other units must convert values to watt-hours or be represented by Energy Objects that convert to watt-hours.

##### 6.4.1. Measurements: Power

The Energy Object (Class) contains a Nameplate Power Attribute that describes the nominal power as specified by the manufacturer of the device. The EnMS can use the Nameplate Power for provisioning, capacity planning, and (potentially) billing.

The Energy Object (Class) has attributes that describe the present power information, along with how that measurement was obtained or derived (e.g., actual, estimated, or static).

A power measurement is qualified with the units, magnitude, and direction of power flow and is qualified as to the means by which the measurement was made.

Power measurement magnitude conforms to the [IEC61850] definition of unit multiplier for the SI (System International) units of measure. Measured values are represented in SI units obtained by  $\text{BaseValue} * (10 ^ \text{Scale})$ . For example, if current power usage of an Energy Object is 17, it could be 17 W, 17 mW, 17 kW, or 17 MW, depending on the value of the scaling factor. 17 W implies that  $\text{BaseValue} = 17$  and  $\text{Scale} = 0$ , whereas 17 mW implies that  $\text{BaseValue} = 17$  and  $\text{ScaleFactor} = -3$ .

An Energy Object (Class) indicates how the power measurement was obtained with a caliber and accuracy attribute that indicates:

- o Whether the measurements were made at the device itself or at a remote source.
- o Description of the method that was used to measure the power and whether this method can distinguish actual or estimated values.
- o Accuracy for actual measured values.

#### 6.4.2. Measurements: Power Attributes

The Energy Object (Class) contains an optional attribute that describes Power Attribute information reflecting the electrical characteristics of the measurement. These Power Attributes adhere to the [IEC61850-7-2] standard for describing AC measurements.

#### 6.4.3. Measurements: Energy

The Energy Object (Class) contains optional attributes that represent the energy used, received, produced, and/or stored. Typically, only devices or components that can measure actual power will have the ability to measure energy.

#### 6.4.4. Measurements: Demand

The Energy Object (Class) contains optional attributes that represent demand information over time. Typically, only devices or components that can report actual power are capable of measuring demand.

#### 6.5. Control

The Energy Object (Class) contains a Power State Set (Class) attribute that represents the set of Power States a device or component supports.

A Power State describes a condition or mode of a device or component. While Power States are typically used for control, they may be used for monitoring only.

A device or component is expected to support at least one set of Power States consisting of at least two states: an on state and an off state.

There are many existing standards describing device and component Power States. The framework supports modeling a mixed set of Power States defined in different standards. A basic example is given by

the three Power States defined in IEEE1621 [IEEE1621]: on, off, and sleep. The Distributed Management Task Force (DMTF) standards organization [DMTF], Advanced Configuration and Power Interface (ACPI) specification [ACPI], and Printer Working Group (PWG) all define larger numbers of Power States.

The semantics of a Power State are specified by:

- a) The functionality provided by an Energy Object in this state.
- b) A limitation of the power that an Energy Object uses in this state.
- c) A combination of a) and b).

The semantics of a Power State should be clearly defined. Limitation (curtailment) of the power used by an Energy Object in a state may be specified by:

- o An absolute power value.
- o A percentage value of power relative to the Energy Object's Nameplate Power.
- o An indication of power relative to another Power State. For example, specify that power in state A is less than in state B.
- o For supporting Power State management, an Energy Object provides statistics on Power States, including the time an Energy Object spent in a certain Power State and the number of times an Energy Object entered a Power State.

When requesting an Energy Object to enter a Power State, an indication of the Power State's name or number can be used. Optionally, an absolute or percentage of Nameplate Power can be provided to allow the Energy Object to transition to a nearest or equivalent Power State.

When an Energy Object is set to a particular Power State, the represented device or component may be busy. The Energy Object should set the desired Power State and then update the actual Power State when the device or component changes. There are then two Power State (Class) control attributes: actual and requested.

The following sections describe well-known Power States for devices and components that should be modeled in the information model.

### 6.5.1. Power State Sets

There are several standards and implementations of Power State Sets. The Energy Object (Class) supports modeling one or multiple Power State Set implementations on the device or component concurrently.

There are currently three Power State Sets specified by IANA:

```
IEEE1621 (256) - [IEEE1621]
DMTF (512)    - [DMTF]
EMAN (768)   - [RFC7326]
```

The respective specific states related to each Power State Set are specified in the following sections. The guidelines for the modification of Power State Sets are specified in the IANA Considerations section.

### 6.5.2. Power State Set: IEEE1621

The IEEE1621 Power State Set [IEEE1621] consists of three rudimentary states: on, off, or sleep.

In IEEE1621, devices are limited to the three basic Power States -- on (2), sleep (1), and off (0). Any additional Power States are variants of one of the basic states, rather than a fourth state [IEEE1621].

### 6.5.3. Power State Set: DMTF

The DMTF [DMTF] standards organization has defined a power profile standard based on the CIM (Common Information Model), which consists of 15 Power States.

The DMTF standard is targeted for hosts and computers. Details of the semantics of each Power State within the DMTF Power State Set can be obtained from the DMTF Power State Management Profile specification [DMTF].

The DMTF power profile extends ACPI Power States. The following table provides a mapping between DMTF and ACPI Power State Sets:

DMTF	ACPI
-----	-----
Reserved (0)	
Reserved (1)	
ON (2)	G0/S0
Sleep-Light (3)	G1/S1 G1/S2
Sleep-Deep (4)	G1/S3
Power Cycle (Off-Soft) (5)	G2/S5
Off-Hard (6)	G3
Hibernate (Off-Soft) (7)	G1/S4
Off-Soft (8)	G2/S5
Power Cycle (Off-Hard) (9)	G3
Master Bus Reset (10)	G2/S5
Diagnostic Interrupt (11)	G2/S5
Off-Soft Graceful (12)	G2/S5
Off-Hard Graceful (13)	G3
MasterBus Reset Graceful (14)	G2/S5
Power Cycle Off-Soft Graceful (15)	G2/S5
Power Cycle Off-Hard Graceful (16)	G3

#### 6.5.4. Power State Set: IETF EMAN

The EMAN Power States are an expansion of the basic Power States as defined in [IEEE1621] plus the addition of the Power States defined in [ACPI] and [DMTF]. Therefore, in addition to the non-operational states as defined in [ACPI] and [DMTF] standards, several intermediate operational states have been defined.

Physical devices and components are expected to support the EMAN Power State Set or to be modeled via an Energy Object that supports these states.

An Energy Object may implement fewer or more Power States than a particular EMAN Power State Set specifies. In that case, the Energy Object implementation can determine its own mapping to the predefined EMAN Power States within the EMAN Power State Set.

There are twelve EMAN Power States that expand on [IEEE1621]. The expanded list of Power States is derived from [CISCO-EW] and is divided into six operational states and six non-operational states.

The lowest non-operational state is 0, and the highest is 5. Each non-operational state corresponds to an [ACPI] Global and System state between G3 (hard-off) and G1 (sleeping). Each operational state represents a performance state and may be mapped to [ACPI] states P0 (maximum performance power) through P5 (minimum performance and minimum power).

In each of the non-operational states (from mechoff(0) to ready(5)), the Power State preceding it is expected to have a lower Power value and a longer delay in returning to an operational state:

mechoff(0): An off state where no Energy Object features are available. The Energy Object is unavailable. No energy is being consumed, and the power connector can be removed.

softoff(1): Similar to mechoff(0), but some components remain powered or receive trace power so that the Energy Object can be awakened from its off state. In softoff(1), no context is saved, and the device typically requires a complete boot when awakened.

hibernate(2): No Energy Object features are available. The Energy Object may be awakened without requiring a complete boot, but the time for availability is longer than sleep(3). An example for state hibernate(2) is a save-to-disk state where DRAM context is not maintained. Typically, energy consumption is zero or close to zero.

sleep(3): No Energy Object features are available, except for out-of-band management, such as wake-up mechanisms. The time for availability is longer than standby(4). An example for state sleep(3) is a save-to-RAM state, where DRAM context is maintained. Typically, energy consumption is close to zero.

standby(4): No Energy Object features are available, except for out-of-band management, such as wake-up mechanisms. This mode is analogous to cold-standby. The time for availability is longer than ready(5). For example, processor context may not be maintained. Typically, energy consumption is close to zero.

ready(5): No Energy Object features are available, except for out-of-band management, such as wake-up mechanisms. This mode is analogous to hot-standby. The Energy Object can be quickly transitioned into an operational state. For example, processors are not executing, but processor context is maintained.

lowMinus(6): Indicates that some Energy Object features may not be available and the Energy Object has taken measures or selected options to use less energy than low(7).

low(7): Indicates that some Energy Object features may not be available and the Energy Object has taken measures or selected options to use less energy than mediumMinus(8).

mediumMinus(8): Indicates that all Energy Object features are available but the Energy Object has taken measures or selected options to use less energy than medium(9).

medium(9): Indicates that all Energy Object features are available but the Energy Object has taken measures or selected options to use less energy than highMinus(10).

highMinus(10): Indicates that all Energy Object features are available and the Energy Object has taken measures or selected options to use less energy than high(11).

high(11): Indicates that all Energy Object features are available and the Energy Object may use the maximum energy as indicated by the Nameplate Power.

#### 6.5.5. Power State Sets Comparison

A comparison of Power States from different Power State Sets can be seen in the following tables:

Non-operational states:

IEEE1621	DMTF	ACPI	EMAN
off	Off-Hard	G3/S5	mechoff(0)
off	Off-Soft	G2/S5	softoff(1)
off	Hibernate	G1/S4	hibernate(2)
sleep	Sleep-Deep	G1/S3	sleep(3)
sleep	Sleep-Light	G1/S2	standby(4)
sleep	Sleep-Light	G1/S1	ready(5)



Operational states:

IEEE1621	DMTF	ACPI	EMAN
on	on	G0/S0/P5	lowMinus(6)
on	on	G0/S0/P4	low(7)
on	on	G0/S0/P3	mediumMinus(8)
on	on	G0/S0/P2	medium(9)
on	on	G0/S0/P1	highMinus(10)
on	on	G0/S0/P0	high(11)

## 6.6. Relationships

The Energy Object (Class) contains a set of Relationship (Class) attributes to model the relationships between devices and components. Two Energy Objects can establish an Energy Object Relationship to model the deployment topology with respect to Energy Management.

Relationships are modeled with a Relationship (Class) that contains the UUID of the other participant in the relationship and a name that describes the type of relationship [CHEN]. The types of relationships are Power Source, Metering, and Aggregations.

- o A Power Source Relationship is a relationship where one Energy Object provides power to one or more Energy Objects. The Power Source Relationship gives a view of the physical wiring topology -- for example, a data center server receiving power from two specific Power Interfaces from two different PDUs.

Note: A Power Source Relationship may or may not change as the direction of power changes between two Energy Objects. The relationship may remain to indicate that the change of power direction was unintended or an error condition.

- o A Metering Relationship is a relationship where one Energy Object measures power, energy, demand, or Power Attributes of one or more other Energy Objects. The Metering Relationship gives the view of the Metering topology. Physical meters can be placed anywhere in a power distribution tree. For example, utility meters monitor and report accumulated power consumption of the entire building. Logically, the Metering topology overlaps with the wiring topology, as meters are connected to the wiring topology. A typical example is meters that clamp onto the existing wiring.

- o An Aggregation Relationship is a relationship where one Energy Object aggregates Energy Management information of one or more other Energy Objects. The Aggregation Relationship gives a model of devices that may aggregate (sum, average, etc.) values for other devices. The Aggregation Relationship is slightly different compared to the other relationships, as this refers more to a management function.

In some situations, it is not possible to discover the Energy Object Relationships, and an EnMS or administrator must set them. Given that relationships can be assigned manually, the following sections describe guidelines for use.

#### 6.6.1. Relationship Conventions and Guidelines

This Energy Management framework does not impose many "MUST" rules related to Energy Object Relationships. There are always corner cases that can be excluded by making stricter specifications for relationships. However, the framework proposes a series of guidelines, indicated with "SHOULD" and "MAY".

#### 6.6.2. Guidelines: Power Source

Power Source Relationships are intended to identify the connections between Power Interfaces. This is analogous to a Layer 2 connection in networking devices (a "one-hop connection").

The preferred modeling would be for Power Interfaces to participate in Power Source Relationships. In some cases, Energy Objects may not have the capability to model Power Interfaces. Therefore, a Power Source Relationship can be established between two Energy Objects or two non-connected Power Interfaces.

Strictly speaking, while components and Power Interfaces on the same Device do provide or receive energy from each other, the Power Source Relationship is intended to show energy transfer between Devices. Therefore, the relationship is implied when on the same Device.

An Energy Object SHOULD NOT establish a Power Source Relationship with a component.

- o A Power Source Relationship SHOULD be established with the next known Power Interface in the wiring topology.

- o The next known Power Interface in the wiring topology would be the next device implementing the framework. In some cases, the domain of devices under management may include some devices that do not implement the framework. In these cases, the Power Source Relationship can be established with the next device in the topology that implements the framework and logically shows the Power Source of the device.
- o Transitive Power Source Relationships SHOULD NOT be established. For example, if Energy Object A has a Power Source Relationship "Poweredby" with Energy Object B, and if Energy Object B has a Power Source Relationship "Poweredby" with Energy Object C, then Energy Object A SHOULD NOT have a Power Source Relationship "Poweredby" with Energy Object C.

### 6.6.3. Guidelines: Metering Relationship

Metering Relationships are intended to show when one device acting as a meter is measuring the power or energy at a point in a power distribution system. Since one point of a power distribution system may cover many devices within a wiring topology, this relationship type can be seen as a set.

Some devices may include hardware that can measure power for components, outlets, or the entire device. For example, some PDUs may have the ability to measure power for each outlet and are commonly referred to as metered-by-outlet. Others may be able to control power at each power outlet but can only measure power at the power inlet -- commonly referred to as metered-by-device.

While the Metering Relationship could be used to represent a device as metered-by-outlet or metered-by-device, the Metering Relationship SHOULD be used to model the relationship between a meter and all devices covered by the meter downstream in the power distribution system.

In general:

- o A Metering Relationship MAY be established with any other Energy Object, component, or Power Interface.
- o Transitive Metering Relationships MAY be used.
- o When there is a series of meters for one Energy Object, the Energy Object MAY establish a Metering Relationship with one or more of the meters.

#### 6.6.4. Guidelines: Aggregation

Aggregation Relationships are intended to identify when one device is used to accumulate values from other devices. Typically, this is for energy or power values among devices and not for components or Power Interfaces on the same device.

The intent of Aggregation Relationships is to indicate when one device is providing aggregate values for a set of other devices when it is not obvious from the power source or simple containment within a device.

Establishing Aggregation Relationships within the same device would make modeling more complex, and the aggregated values can be implied from the use of power inlets, outlet, and Energy Object values on the same device.

Since an EnMS is naturally a point of Aggregation, it is not necessary to model Aggregation for Energy Management Systems.

The Aggregation Relationship is intended for power and energy. It MAY be used for Aggregation of other values from the information model, but the rules and logical ability to aggregate each attribute are out of scope for this document.

In general:

- o A Device SHOULD NOT establish an Aggregation Relationship with components contained on the same device.
- o A Device SHOULD NOT establish an Aggregation Relationship with the Power Interfaces contained on the same device.
- o A Device SHOULD NOT establish an Aggregation Relationship with an EnMS.
- o Aggregators SHOULD log or provide notification in the case of errors or missing values while performing Aggregation.

#### 6.6.5. Energy Object Relationship Extensions

This framework for Energy Management is based on three relationship types: Aggregation, Metering, and Power Source.

This framework is defined with possible future extension of new Energy Object Relationships in mind.

For example:

- o Some Devices that may not be IP connected could be modeled with a proxy relationship to an Energy Object within the domain. This type of proxy relationship is left for further development.
- o A Power Distribution Unit (PDU) that allows devices and components like outlets to be "ganged" together as a logical entity for simplified management purposes could be modeled with an extension called a "gang relationship", whose semantics would specify the Energy Objects' grouping.

### 7. Energy Management Information Model

This section presents an information model expression of the concepts in this framework as a reference for implementers. The information model is implemented as MIB modules in the different related IETF EMAN documents. However, other programming structures with different data models could be used as well.

Data modeling specifications of this information model may, where needed, specify which attributes are required or optional.

Syntax

Unified Modeling Language (UML) Construct [ISO-IEC-19501-2005]	Equivalent Notation
-----	-----
Notes	// Notes
Class (Generalization)	CLASS name {member..}
Subclass (Specialization)	CLASS subclass EXTENDS superclass {member..}
Class Member (Attribute)	attribute : type

## Model

```

CLASS EnergyObject {
    // identification / classification
    index      : int
    name       : string
    identifier  : uuid
    alternatekey : string

    // context
    domainName      : string
    role            : string
    keywords [0..n] : string
    importance      : int

    // relationship
    relationships [0..n] : Relationship

    // measurements
    nameplate      : Nameplate
    power          : PowerMeasurement
    energy         : EnergyMeasurement
    demand        : DemandMeasurement

    // control
    powerControl [0..n] : PowerStateSet
}

CLASS PowerInterface EXTENDS EnergyObject {
    eoIfType : enum { inlet, outlet, both }
}

CLASS Device EXTENDS EnergyObject {
    eocategory      : enum { producer, consumer, meter,
distributor, store }
    powerInterfaces [0..n] : PowerInterface
    components [0..n] : Component
}

CLASS Component EXTENDS EnergyObject {
    eocategory      : enum { producer, consumer, meter,
distributor, store }
    powerInterfaces [0..n] : PowerInterface
    components [0..n] : Component
}

```

```
CLASS Nameplate {
    nominalPower : PowerMeasurement
    details      : URI
}

CLASS Relationship {
    relationshipType : enum { meters, meteredby, powers,
poweredby, aggregates, aggregatedby }
    relationshipObject : uuid
}

CLASS Measurement {
    multiplier : enum { -24..24 }
    caliber    : enum { actual, estimated, static }
    accuracy   : enum { 0..10000 } // hundreds of percent
}

CLASS PowerMeasurement EXTENDS Measurement {
    value      : long
    units      : "W"
    powerAttribute : PowerAttribute
}

CLASS EnergyMeasurement EXTENDS Measurement {
    startTime : time
    units     : "kWh"
    provided  : long
    used      : long
    produced  : long
    stored    : long
}

CLASS TimedMeasurement EXTENDS Measurement {
    startTime : timestamp
    value     : Measurement
    maximum   : Measurement
}

CLASS TimeInterval {
    value      : long
    units     : enum { seconds, milliseconds,... }
}
```

```
CLASS DemandMeasurement EXTENDS Measurement {
    intervalLength      : TimeInterval
    intervals           : long
    intervalMode        : enum { periodic, sliding, total }
    intervalWindow      : TimeInterval
    sampleRate          : TimeInterval
    status              : enum { active, inactive }
    measurements [0..n] : TimedMeasurements
}

CLASS PowerStateSet {
    powerSetIdentifier : int
    name               : string
    powerStates [0..n] : PowerState
    operState          : int
    adminState         : int
    reason             : string
    configuredTime     : timestamp
}

CLASS PowerState {
    powerStateIdentifier : int
    name                 : string
    cardinality          : int
    maximumPower         : PowerMeasurement
    totalTimeInState     : time
    entryCount           : long
}

CLASS PowerAttribute {
    acQuality : ACQuality
}

CLASS ACQuality {
    acConfiguration      : enum { SNGL, DEL, WYE }
    avgVoltage           : long
    avgCurrent           : long
    thdCurrent           : long
    frequency            : long
    unitMultiplier      : int
    accuracy             : int
    totalActivePower     : long
    totalReactivePower   : long
    totalApparentPower   : long
    totalPowerFactor     : long
}
```



```
CLASS DelPhase EXTENDS ACQuality {
    phaseToNextPhaseVoltage : long
    thdVoltage                : long
}

CLASS WYEPhase EXTENDS ACQuality {
    phaseToNeutralVoltage : long
    thdCurrent            : long
    thdVoltage            : long
    avgCurrent            : long
}
```

## 8. Modeling Relationships between Devices

In this section, we give examples of how to use the EMAN information model to model physical topologies. Where applicable, we show how the framework can be applied when devices can be modeled with Power Interfaces. We also show how the framework can be applied when devices cannot be modeled with Power Interfaces but only monitored or controlled as a whole. For instance, a PDU may only be able to measure power and energy for the entire unit without the ability to distinguish among the inlets or outlets.

### 8.1. Power Source Relationship

The Power Source Relationship is used to model the interconnections between devices, components, and/or Power Interfaces to indicate the source of energy for a device.

In the following examples, we show variations on modeling the reference topologies using relationships.

Given for all cases:

Device W: A computer with one power supply. Power Interface 1 is an inlet for Device W.

Device X: A computer with two power supplies. Power Interface 1 and Power Interface 2 are both inlets for Device X.

Device Y: A PDU with multiple Power Interfaces numbered 0..10. Power Interface 0 is an inlet, and Power Interfaces 1..10 are outlets.

Device Z: A PDU with multiple Power Interfaces numbered 0..10. Power Interface 0 is an inlet, and Power Interfaces 1..10 are outlets.

Case 1: Simple Device with one Source

Physical Topology:

- o Device W inlet 1 is plugged into Device Y outlet 8.

With Power Interfaces:

- o Device W has an Energy Object representing the computer itself as well as one Power Interface defined as an inlet.
- o Device Y would have an Energy Object representing the PDU itself (the Device), with Power Interface 0 defined as an inlet and Power Interfaces 1..10 defined as outlets.

The interfaces of the devices would have a Power Source Relationship such that:

Device W inlet 1 is powered by Device Y outlet 8.

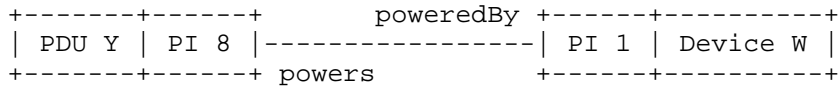

Without Power Interfaces:

- o Device W has an Energy Object representing the computer.
- o Device Y would have an Energy Object representing the PDU.

The devices would have a Power Source Relationship such that:

Device W is powered by Device Y.

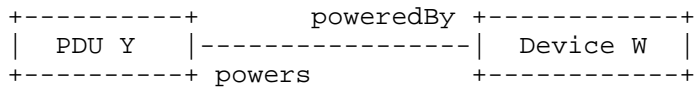

Case 2: Multiple Inlets

Physical Topology:

- o Device X inlet 1 is plugged into Device Y outlet 8.
- o Device X inlet 2 is plugged into Device Y outlet 9.

With Power Interfaces:

- o Device X has an Energy Object representing the computer itself. It contains two Power Interfaces defined as inlets.
- o Device Y would have an Energy Object representing the PDU itself (the Device), with Power Interface 0 defined as an inlet and Power Interfaces 1..10 defined as outlets.

The interfaces of the devices would have a Power Source Relationship such that:

Device X inlet 1 is powered by Device Y outlet 8.

Device X inlet 2 is powered by Device Y outlet 9.

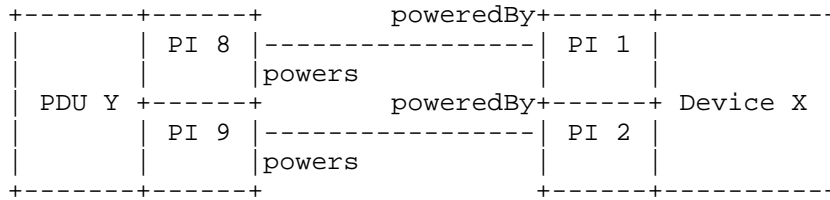

Without Power Interfaces:

- o Device X has an Energy Object representing the computer. Device Y has an Energy Object representing the PDU.

The devices would have a Power Source Relationship such that:

Device X is powered by Device Y.

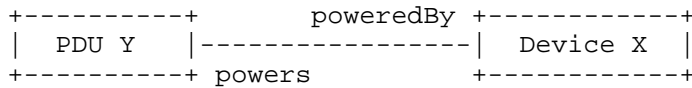

Case 3: Multiple Sources

Physical Topology:

- o Device X inlet 1 is plugged into Device Y outlet 8.
- o Device X inlet 2 is plugged into Device Z outlet 9.

With Power Interfaces:

- o Device X has an Energy Object representing the computer itself. It contains two Power Interfaces defined as inlets.
- o Device Y would have an Energy Object representing the PDU itself (the Device), with Power Interface 0 defined as an inlet and Power Interfaces 1..10 defined as outlets.
- o Device Z would have an Energy Object representing the PDU itself (the Device), with Power Interface 0 defined as an inlet and Power Interfaces 1..10 defined as outlets.

The interfaces of the devices would have a Power Source Relationship such that:

Device X inlet 1 is powered by Device Y outlet 8.

Device X inlet 2 is powered by Device Z outlet 9.

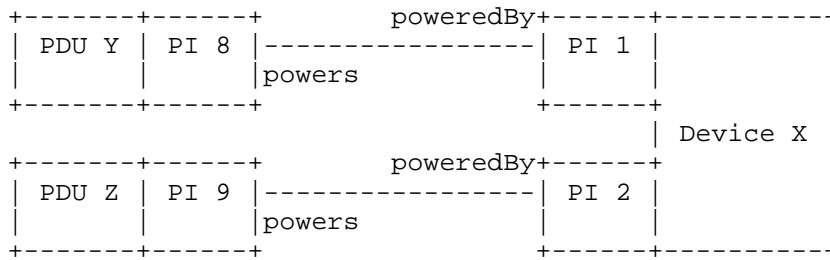

Without Power Interfaces:

- o Device X has an Energy Object representing the computer. Devices Y and Z would both have respective Energy Objects representing each entire PDU.

The devices would have a Power Source Relationship such that:

Device X is powered by Device Y and powered by Device Z.

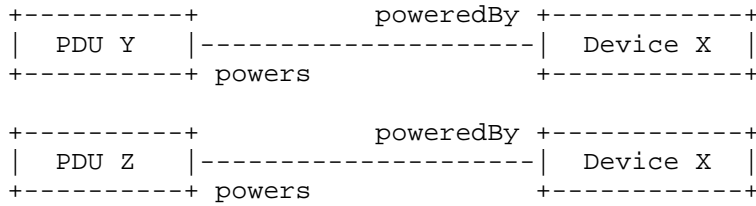

### 8.2. Metering Relationship

A meter in a power distribution system can logically measure the power or energy for all devices downstream from the meter in the power distribution system. As such, a Metering Relationship can be seen as a relationship between a meter and all of the devices downstream from the meter.

We define in this case a Metering Relationship between a meter and devices downstream from the meter.

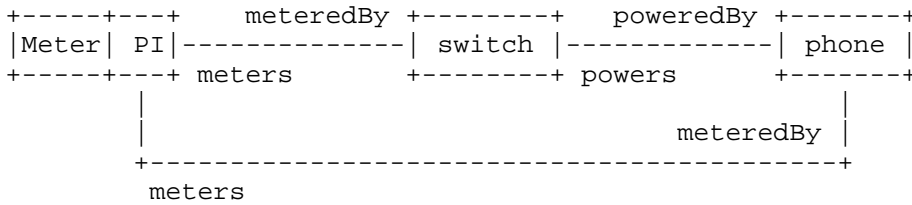

In cases where the Power Source topology cannot be discovered or derived from the information available in the Energy Management Domain, the Metering topology can be used to relate the upstream meter to the downstream devices in the absence of specific Power Source Relationships.

A Metering Relationship can occur between devices that are not directly connected, as shown in the following figure:

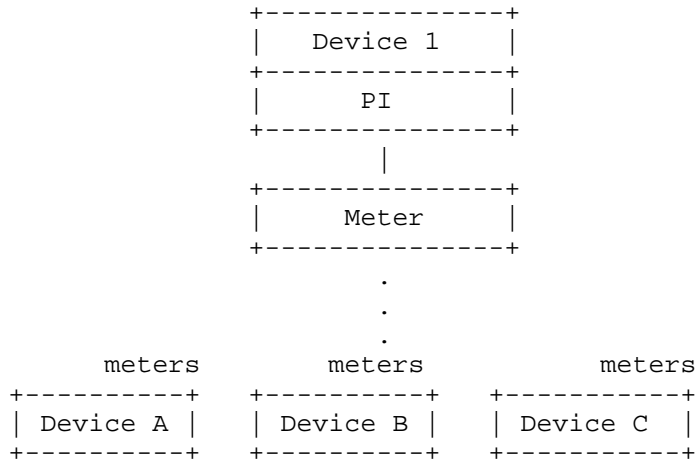

An analogy to communications networks would be modeling connections between servers (meters) and clients (devices) when the complete Layer 2 topology between the servers and clients is not known.

### 8.3. Aggregation Relationship

Some devices can act as Aggregation points for other devices. For example, a PDU controller device may contain the summation of power and energy readings for many PDU devices. The PDU controller will have aggregate values for power and energy for a group of PDU devices.

This Aggregation is independent of the physical power or communication topology.

The functions that the Aggregation point may perform include the calculation of values such as average, count, maximum, median, minimum, or the listing (collection) of the Aggregation values, etc.

Based on IETF experience gained on Aggregations [RFC7015], the Aggregation function in the EMAN framework is limited to the summation.

When Aggregation occurs across a set of entities, values to be aggregated may be missing for some entities. The EMAN framework does not specify how these should be treated, as different implementations may have good reason to take different approaches. One common treatment is to define the Aggregation as missing if any of the

constituent elements are missing (useful to be most precise). Another is to treat the missing value as zero (useful to have continuous data streams).

The specifications of Aggregation functions are out of the scope of the EMAN framework but must be clearly specified by the equipment vendor.

## 9. Relationship to Other Standards

This Energy Management framework uses, as much as possible, existing standards, especially with respect to information modeling and data modeling [RFC3444].

The data model for power- and energy-related objects is based on [IEC61850].

Specific examples include:

- o The scaling factor, which represents Energy Object usage magnitude, conforms to the [IEC61850] definition of unit multiplier for the SI (System International) units of measure.
- o The electrical characteristics are based on the ANSI and IEC Standards, which require that we use an accuracy class for power measurement. ANSI and IEC define the following accuracy classes for power measurement:
  - IEC 62053-22 and 60044-1 classes 0.1, 0.2, 0.5, 1, and 3.
  - ANSI C12.20 classes 0.2 and 0.5.
- o The electrical characteristics and quality adhere closely to the [IEC61850-7-4] standard for describing AC measurements.
- o The Power State definitions are based on the DMTF Power State Profile and ACPI models, with operational state extensions.

## 10. Security Considerations

Regarding the data attributes specified here, some or all may be considered sensitive or vulnerable in some network environments. Reading or writing these attributes without proper protection such as encryption or access authorization will have negative effects on network capabilities. Event logs for audit purposes on configuration and other changes should be generated according to current

authorization, audit, and accounting principles to facilitate investigations (compromise or benign misconfigurations) or any reporting requirements.

The information and control capabilities specified in this framework could be exploited, to the detriment of a site or deployment. Implementers of the framework SHOULD examine and mitigate security threats with respect to these new capabilities.

"User-based Security Model (USM) for version 3 of the Simple Network Management Protocol (SNMPv3)" [RFC3414] presents a good description of threats and mitigations for SNMPv3 that can be used as a guide for implementations of this framework using other protocols.

#### 10.1. Security Considerations for SNMP

Readable objects in MIB modules (i.e., objects with a MAX-ACCESS other than not-accessible) may be considered sensitive or vulnerable in some network environments. It is important to control GET and/or NOTIFY access to these objects and possibly to encrypt the values of these objects when sending them over the network via SNMP.

The support for SET operations in a non-secure environment without proper protection can have a negative effect on network operations.

For example:

- o Unauthorized changes to the Energy Management Domain or business context of a device will result in misreporting or interruption of power.
- o Unauthorized changes to a Power State will disrupt the power settings of the different devices and therefore the state of functionality of the respective devices.
- o Unauthorized changes to the demand history will disrupt proper accounting of energy usage.

With respect to data transport, SNMP versions prior to SNMPv3 did not include adequate security. Even if the network itself is secure (for example, by using IPsec), there is still no secure control over who on the secure network is allowed to access and GET/SET (read/change/create/delete) the objects in these MIB modules.

It is recommended that implementers consider the security features as provided by the SNMPv3 framework (see [RFC3411]), including full support for the SNMPv3 cryptographic mechanisms (for authentication and confidentiality).



Further, deployment of SNMP versions prior to SNMPv3 is not recommended. Instead, it is recommended to deploy SNMPv3 and to enable cryptographic security. It is then a customer/operator responsibility to ensure that the SNMP entity giving access to an instance of these MIB modules is properly configured to give access to the objects only to those principals (users) that have legitimate rights to GET or SET (change/create/delete) them.

## 11. IANA Considerations

### 11.1. IANA Registration of New Power State Sets

This document specifies an initial set of Power State Sets. The list of these Power State Sets with their numeric identifiers is given in Section 6. IANA maintains the lists of Power State Sets.

New assignments for a Power State Set are administered by IANA through Expert Review [RFC5226], i.e., review by one of a group of experts designated by an IETF Area Director. The group of experts must check the requested state for completeness and accuracy of the description. A pure vendor-specific implementation of a Power State Set shall not be adopted, since it would lead to proliferation of Power State Sets.

Power States in a Power State Set are limited to 255 distinct values. A new Power State Set must be assigned the next available numeric identifier that is a multiple of 256.

#### 11.1.1. IANA Registration of the IEEE1621 Power State Set

This document specifies a set of values for the IEEE1621 Power State Set [IEEE1621]. The list of these values with their identifiers is given in Section 6.5.2. IANA created a new registry for IEEE1621 Power State Set identifiers and filled it with the initial list of identifiers.

New assignments (or, potentially, deprecation) for the IEEE1621 Power State Set are administered by IANA through Expert Review [RFC5226].

#### 11.1.2. IANA Registration of the DMTF Power State Set

This document specifies a set of values for the DMTF Power State Set [DMTF]. The list of these values with their identifiers is given in Section 6.5.3. IANA has created a new registry for DMTF Power State Set identifiers and filled it with the initial list of identifiers.

New assignments (or, potentially, deprecation) for the DMTF Power State Set are administered by IANA through Expert Review [RFC5226].

The group of experts must check for conformance with the DMTF standard [DMTF] in addition to checking for completeness and accuracy of the description.

#### 11.1.3. IANA Registration of the EMAN Power State Set

This document specifies a set of values for the EMAN Power State Set. The list of these values with their identifiers is given in Section 6.5.4. IANA has created a new registry for EMAN Power State Set identifiers and filled it with the initial list of identifiers.

New assignments (or, potentially, deprecation) for the EMAN Power State Set are administered by IANA through Expert Review [RFC5226].

#### 11.2. Updating the Registration of Existing Power State Sets

With the evolution of standards, over time, it may be important to deprecate some of the existing Power State Sets, or to add or deprecate some Power States within a Power State Set.

The registrant shall post an Internet-Draft with the clear specification on deprecation of Power State Sets or Power States registered with IANA. The deprecation or addition shall be administered by IANA through Expert Review [RFC5226], i.e., review by one of a group of experts designated by an IETF Area Director. The process should also allow for a mechanism for cases where others have significant objections to claims regarding the deprecation of a registration.

## 12. References

### 12.1. Normative References

- [RFC2119] Bradner, S., "Key words for use in RFCs to Indicate Requirement Levels", BCP 14, RFC 2119, March 1997.
- [RFC3411] Harrington, D., Presuhn, R., and B. Wijnen, "An Architecture for Describing Simple Network Management Protocol (SNMP) Management Frameworks", STD 62, RFC 3411, December 2002.
- [RFC3414] Blumenthal, U. and B. Wijnen, "User-based Security Model (USM) for version 3 of the Simple Network Management Protocol (SNMPv3)", STD 62, RFC 3414, December 2002.
- [RFC3444] Pras, A. and J. Schoenwaelder, "On the Difference between Information Models and Data Models", RFC 3444, January 2003.
- [RFC4122] Leach, P., Mealling, M., and R. Salz, "A Universally Unique Identifier (UUID) URN Namespace", RFC 4122, July 2005.
- [RFC5226] Narten, T. and H. Alvestrand, "Guidelines for Writing an IANA Considerations Section in RFCs", BCP 26, RFC 5226, May 2008.
- [RFC6933] Bierman, A., Romascanu, D., Quittek, J., and M. Chandramouli, "Entity MIB (Version 4)", RFC 6933, May 2013.
- [RFC6988] Quittek, J., Ed., Chandramouli, M., Winter, R., Dietz, T., and B. Claise, "Requirements for Energy Management", RFC 6988, September 2013.
- [ISO-IEC-19501-2005] ISO/IEC 19501:2005, Information technology, Open Distributed Processing -- Unified Modeling Language (UML) Version 1.4.2, January 2005.

## 12.2. Informative References

- [RFC3986] Berners-Lee, T., Fielding, R., and L. Masinter, "Uniform Resource Identifier (URI): Generic Syntax", STD 66, RFC 3986, January 2005.
- [RFC7015] Trammell, B., Wagner, A., and B. Claise, "Flow Aggregation for the IP Flow Information Export (IPFIX) Protocol", RFC 7015, September 2013.
- [ACPI] "Advanced Configuration and Power Interface Specification", October 2006, <<http://www.acpi.info/spec30b.htm>>.
- [IEEE1621] "Standard for User Interface Elements in Power Control of Electronic Devices Employed in Office/Consumer Environments", IEEE 1621, December 2004.
- [NMF] Clemm, A., "Network Management Fundamentals", ISBN-10: 1-58720-137-2, Cisco Press, November 2006.
- [TMN] International Telecommunication Union, "TMN management functions", ITU-T Recommendation M.3400, February 2000.
- [IEEE100] "The Authoritative Dictionary of IEEE Standards Terms", <<http://ieeexplore.ieee.org/xpl/mostRecentIssue.jsp?punumber=4116785>>.
- [ISO50001] "ISO 50001:2011 Energy management systems -- Requirements with guidance for use", June 2011, <<http://www.iso.org/>>.
- [IEC60050] "International Electrotechnical Vocabulary", <<http://www.electropedia.org/iev/iev.nsf/welcome?openform>>.
- [IEC61850] "Power Utility Automation", <<http://www.iec.ch/smartgrid/standards/>>.
- [IEC61850-7-2] "Abstract communication service interface (ACSI)", <<http://www.iec.ch/smartgrid/standards/>>.
- [IEC61850-7-4] "Compatible logical node classes and data classes", <<http://www.iec.ch/smartgrid/standards/>>.

- [DMTF] "Power State Management Profile", DMTF DSP1027  
Version 2.0.0, December 2009,  
<[http://www.dmtf.org/sites/default/files/standards/documents/DSP1027\\_2.0.0.pdf](http://www.dmtf.org/sites/default/files/standards/documents/DSP1027_2.0.0.pdf)>.
- [IPENERGY] Aldrich, R. and J. Parello, "IP-Enabled Energy Management: A Proven Strategy for Administering Energy as a Service", 2010, Wiley Publishing.
- [X.700] CCITT Recommendation X.700, "Management framework for Open Systems Interconnection (OSI) for CCITT applications", September 1992.
- [ASHRAE-201] "ASHRAE Standard Project Committee 201 (SPC 201) Facility Smart Grid Information Model",  
<<http://spc201.ashraeeps.org>>.
- [CHEN] Chen, P., "The Entity-Relationship Model: Toward a Unified View of Data", ACM Transactions on Database Systems (TODS), March 1976.
- [CISCO-EW] Parello, J., Saville, R., and S. Kramling, "Cisco EnergyWise Design Guide", Cisco Validated Design (CVD), September 2011,  
<[http://www.cisco.com/en/US/docs/solutions/Enterprise/Borderless\\_Networks/Energy\\_Management/energywisedg.html](http://www.cisco.com/en/US/docs/solutions/Enterprise/Borderless_Networks/Energy_Management/energywisedg.html)>.

### 13. Acknowledgments

The authors would like to thank Michael Brown for his editorial work, which improved the text dramatically. Thanks to Rolf Winter for his feedback, and to Bill Mielke for his feedback and very detailed review. Thanks to Bruce Nordman for brainstorming, with numerous conference calls and discussions. Finally, the authors would like to thank the EMAN chairs: Nevil Brownlee, Bruce Nordman, and Tom Nadeau.

## Appendix A. Information Model Listing

## A. EnergyObject (Class):

r	index	Integer	An [RFC6933] entPhysicalIndex
w	name	String	An [RFC6933] entPhysicalName
r	identifier	uuid	An [RFC6933] entPhysicalUUID
rw	alternatekey	String	A manufacturer-defined string that can be used to identify the Energy Object
rw	domainName	String	The name of an Energy Management Domain for the Energy Object
rw	role	String	An administratively assigned name to indicate the purpose an Energy Object serves in the network
rw	keywords	String	A list of keywords or [0..n] tags that can be used to group Energy Objects for reporting or searching
rw	importance	Integer	Specifies a ranking of how important the Energy Object is (on a scale of 1 to 100) compared with other Energy Objects
rw	relationships [0..n]	Relationship	A list of relationships between this Energy Object and other Energy Objects
r	nameplate	Nameplate	The nominal PowerMeasurement of the Energy Object as specified by the device manufacturer
r	power	PowerMeasurement	The present power measurement of the Energy Object
r	energy	EnergyMeasurement	The present energy measurement for the Energy Object
r	demand	DemandMeasurement	The present demand measurement for the Energy Object

r powerControl PowerStateSet A list of Power States Sets the  
[0..n] Energy Object supports

B. PowerInterface (Class) inherits from EnergyObject:

r eoIfType Enumeration Indicates whether the Power  
Interface is an inlet, outlet,  
or both

C. Device (Class) inherits from EnergyObject:

rw eocategory Enumeration Broadly indicates whether  
the Device is a producer,  
consumer, meter, distributor,  
or store of energy

r powerInterfaces PowerInterface A list of PowerInterfaces  
[0..n] contained in this Device

r components Component A list of components  
[0..n] contained in this Device

D. Component (Class) inherits from EnergyObject:

rw eocategory Enumeration Broadly indicates whether the  
component is a producer,  
consumer, meter, distributor, or  
store of energy

r powerInterfaces PowerInterface A list of PowerInterfaces  
[0..n] contained in this component

r components Component A list of components contained  
[0..n] in this component

## E. Nameplate (Class):

r nominalPower	PowerMeasurement	The nominal power of the Energy as specified by the device manufacturer
rw details	URI	An [RFC3986] URI that links to manufacturer information about the nominal power of a device

## F. Relationship (Class):

rw relationshipType	Enumeration	A description of the relationship, indicating meters, meteredby, powers, poweredby, aggregates, or aggregatedby
rw relationshipObject	uuid	An [RFC6933] entPhysicalUUID that indicates the other participating Energy Object in the relationship

## G. Measurement (Class):

r multiplier	Enumeration	The magnitude of the Measurement in the range -24..24
r caliber	Enumeration	Specifies how the Measurement was obtained -- actual, estimated, or static
r accuracy	Enumeration	Specifies the accuracy of the measurement, if applicable, as 0..10000, indicating hundreds of percent

## H. PowerMeasurement (Class) inherits from Measurement:

r value	Long	A measurement value of power
r units	"W"	The units of measure for the power -- "Watts"



r powerAttribute PowerAttribute Measurement of the electrical current -- voltage, phase, and/or frequencies for the PowerMeasurement

I. EnergyMeasurement (Class) inherits from Measurement:

r startTime Time Specifies the start time of the EnergyMeasurement interval

r units "kWh" The units of measure for the energy -- kilowatt-hours

r provided Long A measurement of energy provided

r used Long A measurement of energy used/consumed

r produced Long A measurement of energy produced

r stored Long A measurement of energy stored

J. TimedMeasurement (Class) inherits from Measurement:

r startTime timestamp A start time of a measurement

r value Measurement A measurement value

r maximum Measurement A maximum value measured since a previous timestamp

K. TimeInterval (Class):

r value Long A value of time

r units Enumeration A magnitude of time, expressed as seconds with an SI prefix (milliseconds, etc.)

L. DemandMeasurement (Class) inherits from Measurement:

rw intervalLength TimeInterval The length of time over which to compute average energy

rw intervals Long The number of intervals that can be measured

rw intervalMode	Enumeration	The mode of interval measurement -- periodic, sliding, or total
rw intervalWindow	TimeInterval	The duration between the starting time of one sliding window and the next starting time
rw sampleRate	TimeInterval	The sampling rate at which to poll power in order to compute demand
rw status	Enumeration	A control to start or stop demand measurement -- active or inactive
r measurements [0..n]	TimedMeasurement	A collection of TimedMeasurements to compute demand

## M. PowerStateSet (Class):

r powerSetIdentifier	Integer	An IANA-assigned value indicating a Power State Set
r name	String	A Power State Set name
r powerStates [0..n]	PowerState	A set of Power States for the given identifier
rw operState	Integer	The current operational Power State
rw adminState	Integer	The desired Power State
rw reason	String	Describes the reason for the adminState
r configuredTime	timestamp	Indicates the time of the desired Power State

## N. PowerState (Class):

r powerStateIdentifier	Integer	An IANA-assigned value indicating a Power State
r name	String	A name for the Power State

r cardinality	Integer	A value indicating an ordering of the Power State
rw maximumPower	PowerMeasurement	Indicates the maximum power for the Energy Object at this Power State
r totalTimeInState	Time	Indicates the total time an Energy Object has been in this Power State since the last reset
r entryCount	Long	Indicates the number of times the Energy Object has entered or changed to this state

## O. PowerAttribute (Class):

r acQuality	ACQuality	Describes AC Power Attributes for a Measurement
-------------	-----------	---

## P. ACQuality (Class):

r acConfiguration	Enumeration	Describes the physical configuration of alternating current as single phase (SNGL), three-phase delta (DEL), or three-phase Y (WYE)
r avgVoltage	Long	The average of the voltage measured over an integral number of AC cycles [IEC61850-7-4] 'Vol'
r avgCurrent	Long	The current per phase [IEC61850-7-4] 'Amp'
r thdCurrent	Long	A calculated value for the current Total Harmonic Distortion (THD). The method of calculation is not specified [IEC61850-7-4] 'ThdAmp'
r frequency	Long	Basic frequency of the AC circuit [IEC61850-7-4] 'Hz'
r unitMultiplier	Integer	Magnitude of watts for the usage value in this instance

r accuracy	Integer	Percentage value in 100ths of a percent, representing the presumed accuracy of active, reactive, and apparent power in this instance
r totalActivePower	Long	A measured value of the actual power delivered to or consumed by the load [IEC61850-7-4] 'TotW'
r totalReactivePower	Long	A measured value of the reactive portion of the apparent power [IEC61850-7-4] 'TotVAr'
r totalApparentPower	Long	A measured value of the voltage and current, which determines the apparent power as the vector sum of real and reactive power [IEC61850-7-4] 'TotVA'
r totalPowerFactor	Long	A measured value of the ratio of the real power flowing to the load versus the apparent power [IEC61850-7-4] 'TotPF'

Q. DelPhase (Class) inherits from ACQuality:

r phaseToNext PhaseVoltage	Long	A measured value of phase to next phase voltages where the next phase is [IEC61850-7-4] 'PPV'
r thdVoltage	Long	A calculated value for the voltage Total Harmonic Distortion (THD) for phase to next phase. The method of calculation is not specified [IEC61850-7-4] 'ThdPPV'

R. WYEPHASE (Class) inherits from ACQuality:

r phaseToNeutral Voltage	Long	A measured value of phase to neutral voltage [IEC61850-7-4] 'PhV'
r thdCurrent	Long	A calculated value for the current Total Harmonic Distortion (THD). The method of calculation is not specified [IEC61850-7-4] 'ThdA'
r thdVoltage	Long	A calculated value of the voltage THD for phase to neutral [IEC61850-7-4] 'ThdPhV'
r avgCurrent	Long	A measured value of phase currents [IEC61850-7-4] 'A'

## Authors' Addresses

John Parello  
Cisco Systems, Inc.  
3550 Cisco Way  
San Jose, CA 95134  
US

Phone: +1 408 525 2339  
EMail: [jparello@cisco.com](mailto:jparello@cisco.com)

Benoit Claise  
Cisco Systems, Inc.  
De Kleetlaan 6a b1  
Diegem 1813  
BE

Phone: +32 2 704 5622  
EMail: [bclaise@cisco.com](mailto:bclaise@cisco.com)

Brad Schoening  
44 Rivers Edge Drive  
Little Silver, NJ 07739  
US

EMail: [brad.schoening@verizon.net](mailto:brad.schoening@verizon.net)

Juergen Quittek  
NEC Europe Ltd.  
Network Laboratories  
Kurfuersten-Anlage 36  
69115 Heidelberg  
Germany

Phone: +49 6221 90511 15  
EMail: [quittek@netlab.nec.de](mailto:quittek@netlab.nec.de)

